

# Operating Instructions

**AccuPocket 150/400 TIG**  
**ActiveCharger 1000**

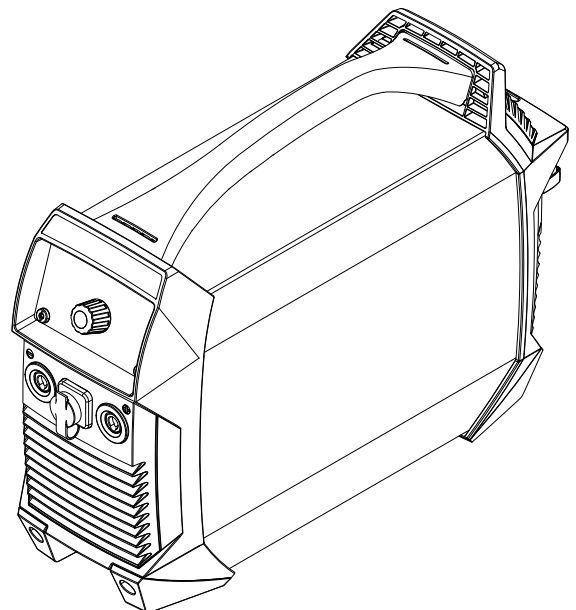

**EN** | Operating instructions





# Contents

<b>Safety rules</b>	<b>7</b>
General.....	9
Explanation of safety notices .....	9
Environmental conditions.....	9
Obligations of the operator.....	9
Obligations of personnel.....	10
EMC Device Classifications.....	10
Disposal.....	10
Data protection .....	10
Copyright.....	10
Power source .....	11
General.....	11
Proper use .....	11
Protecting yourself and others.....	12
Noise emission values.....	12
Danger from toxic gases and vapours.....	12
Danger from flying sparks .....	13
Dangers from welding current.....	13
Dangers from the battery.....	14
Meandering welding currents .....	15
EMC measures.....	15
EMF measures.....	16
Requirement for the shielding gas.....	16
Danger from shielding gas cylinders.....	16
Danger from escaping shielding gas.....	17
Safety precautions in the place of use and for storage and transport.....	17
Safety measures in normal operation.....	18
Safety inspection.....	18
Commissioning, maintenance and repair .....	18
Safety symbols.....	19
Charger .....	20
General.....	20
Environmental conditions.....	20
Intended use.....	20
Mains connection.....	20
Dangers from mains current and charging current.....	21
Protecting yourself and others.....	21
Safety measures in normal operation.....	21
EMC measures.....	22
Maintenance.....	22
Maintenance and repair.....	22
Warranty and liability .....	22
Safety inspection.....	22
Markings on the device.....	23
General and electrical risks.....	23
<b>Power source</b>	<b>25</b>
General.....	27
Device concept.....	27
Warning notices on the device.....	27
Application areas.....	28
Using rechargeable devices.....	29
Safety .....	29
Storage and transport.....	29
Service life of the battery.....	29
Battery protection functions .....	31

General.....	31
Deep discharge protector.....	31
Automatic switch-off.....	31
Temperature monitoring.....	32
Overcharging protection.....	32
Before commissioning.....	33
Safety.....	33
Proper use.....	33
Setup regulations.....	33
Power connection.....	33
Before starting for the first time.....	34
Control elements and connections.....	35
Safety.....	35
Connections and mechanical components.....	35
Control panel.....	37
MMA welding.....	39
Preparatory work.....	39
MMA welding.....	39
SoftStart / HotStart function.....	39
Arc-force dynamic.....	41
TIG modes.....	42
Symbols and their explanations.....	42
2-step mode.....	42
4-step mode.....	43
TIG welding.....	44
General.....	44
Connecting the gas cylinder.....	44
Preparation.....	44
Setting the gas pressure.....	45
TIG welding.....	45
TIG Comfort Stop.....	46
TIG pulsing.....	48
Tacking function.....	49
The Setup menu.....	50
Accessing the Setup menu.....	50
Changing welding parameters.....	50
Exiting the Setup menu.....	50
Parameters for MMA welding.....	50
Parameters for TIG welding.....	52
VRD safety device (optional).....	54
General.....	54
Function.....	54
Care and maintenance.....	55
Safety.....	55
General.....	55
At every start-up.....	55
Every 2 months.....	56
Disposal.....	57
General.....	57
Safety.....	57
Removing the rechargeable battery pack.....	58
Troubleshooting.....	61
Safety.....	61
Indicated errors.....	61
Service messages.....	62
No function.....	63
Faulty operation.....	64
Technical data.....	66
Environmental conditions.....	66
Explanation of the term "duty cycle".....	66
Technical data.....	67

<b>Charger</b>	<b>69</b>
General.....	71
Warning notices on the device.....	71
Warning notices inside the device.....	72
Intended use.....	72
Before commissioning.....	73
Mains connection.....	73
Generator-powered operation.....	73
Setup regulations.....	73
Space requirements.....	74
Control elements and connections.....	75
Safety.....	75
Connections and components.....	75
Control panel.....	75
Start-up.....	76
Safety.....	76
Commissioning.....	76
Operating modes.....	77
Options.....	78
Fitting the wall bracket.....	78
Troubleshooting.....	79
Safety.....	79
Indicated errors.....	79
No function.....	79
Technical data.....	80
Environmental conditions.....	80
Technical data 230V.....	81
Standards 230V.....	81
Technical data 120V.....	82
Standards 120V.....	82
Technical data 100V.....	83
Standards 100V.....	83



# **Safety rules**





## Explanation of safety notices

### **DANGER!**

**Indicates immediate danger.**

- ▶ If not avoided, death or serious injury will result.

### **WARNING!**

**Indicates a potentially hazardous situation.**

- ▶ If not avoided, death or serious injury may result.

### **CAUTION!**

**Indicates a situation where damage or injury could occur.**

- ▶ If not avoided, minor injury and/or damage to property may result.

### **NOTE!**

**Indicates a risk of flawed results and possible damage to the equipment.**

## Environmental conditions

Transport, storage or operation of the device outside the stipulated range will be deemed improper. The manufacturer shall not be held liable for any damage arising from such usage.

Ambient air temperature range:

- During operation: -10 °C to + 40 °C (14 °F to 104 °F)
- During transport: -20 °C to +55 °C (-4 °F to 131 °F)
- Recommended temperature range during charging:  
+ 4 °C to + 40 °C (+ 39.2 °F to + 104 °F)
- Recommended temperature range during storage:  
0 °C to + 20 °C (+ 32 °F to + 68 °F)

When placing in storage, the state of charge should ideally be at 50 - 80% (corresponds to approx. 2 to 3 bars on the charging status indication).

Relative humidity:

- Up to 50% at 40 °C (104 °F)
- Up to 90 % at 20 °C (68 °F)

The surrounding air must be free from dust, acids, corrosive gases or substances, etc.

Can be used at altitudes up to 2000 m (6561 ft.)

## Obligations of the operator

The operator must only allow persons to work with the device who:

- are familiar with the fundamental instructions regarding safety at work and accident prevention and have been instructed in how to use the device
- have read and understood these operating instructions, especially the section "safety rules", and have confirmed as much with their signatures
- are trained to produce the required results.

Checks must be carried out at regular intervals to ensure that operators are working in a safety-conscious manner.

---

**Obligations of personnel**

Before using the device, all persons instructed to do so undertake:

- to observe the basic instructions regarding safety at work and accident prevention
  - to read these operating instructions, especially the "Safety rules" section and sign to confirm that they have understood them and will follow them.
- 

Before leaving the workplace, ensure that people or property cannot come to any harm in your absence.

---

**EMC Device Classifications**

Devices in emission class A:

- Are only designed for use in industrial settings
  - Can cause line-bound and radiated interference in other areas
- 

Devices in emission class B:

- Satisfy the emissions criteria for residential and industrial areas. This is also true for residential areas in which the energy is supplied from the public low-voltage mains.
- 

EMC device classification as per the rating plate or technical data.

---

**Disposal**

Waste electrical and electronic equipment must be collected separately and recycled in an environmentally-friendly way, in accordance with the European Directive and national legislation. Used equipment must be returned to the distributor or disposed of via an approved local collection and disposal facility. Correct disposal of used equipment promotes the sustainable recycling of material resources. Failing to dispose of used equipment correctly can lead to adverse health and/or environmental impacts.

**Packaging materials**

Separate collection according to material. Check your local authority regulations. Crush containers to reduce size.

---

**Data protection**

The user is responsible for the safekeeping of any changes made to the factory settings. The manufacturer accepts no liability for any deleted personal settings.

---

**Copyright**

Copyright of these operating instructions remains with the manufacturer.

---

The text and illustrations are all technically correct at the time of printing. We reserve the right to make changes. The contents of the operating instructions shall not provide the basis for any claims whatsoever on the part of the purchaser. If you have any suggestions for improvement, or can point out any mistakes that you have found in the instructions, we will be most grateful for your comments.

# Power source

---

## General

The device is manufactured using state-of-the-art technology and according to recognised safety standards. If used incorrectly or misused, however, it can cause:

- injury or death to the operator or a third party,
  - damage to the device and other material assets belonging to the operating company,
  - inefficient operation of the device.
- 

All persons involved in commissioning, operating, maintaining and servicing the device must:

- be suitably qualified,
  - have sufficient knowledge of welding and
  - read and follow these operating instructions carefully.
- 

The operating instructions must always be at hand wherever the device is being used. In addition to the operating instructions, attention must also be paid to any generally applicable and local regulations regarding accident prevention and environmental protection.

---

All safety and danger notices on the device

- must be in a legible state,
  - must not be damaged,
  - must not be removed,
  - must not be covered, pasted or painted over.
- 

For the location of the safety and danger notices on the device, refer to the section headed "General" in the operating instructions for the device. Before switching on the device, rectify any faults that could compromise safety.

**This is for your personal safety!**

---

## Proper use

The device is to be used exclusively for its intended purpose.

---

The device is intended solely for the welding processes specified on the rating plate.

Any use above and beyond this purpose is deemed improper. The manufacturer shall not be held liable for any damage arising from such usage.

---

Proper use includes:

- carefully reading and following all the instructions given in the operating instructions
  - studying and obeying all safety and danger notices carefully
  - performing all stipulated inspection and maintenance work.
- 

Never use the device for the following purposes:

- Thawing out pipes
  - Charging batteries
  - Starting engines
- 

The device is designed for use in industry and the workshop. The manufacturer accepts no responsibility for any damage caused through use in a domestic setting.

---

The manufacturer likewise accepts no liability for inadequate or incorrect results.

---

**Protecting yourself and others**

Anyone working with the device exposes themselves to numerous risks, e.g.

- flying sparks and hot pieces of metal
- Arc radiation, which can damage eyes and skin
- Hazardous electromagnetic fields, which can endanger the lives of those using cardiac pacemakers
- Risk of electrocution from mains current and welding current
- Greater noise pollution
- Harmful welding fumes and gases

---

Suitable protective clothing must be worn when working with the device. The protective clothing must have the following properties:

- Flame-resistant
- Insulating and dry
- Covers the whole body, is undamaged and in good condition
- Safety helmet
- Trousers with no turn-ups

---

Protective clothing refers to a variety of different items. Operators should:

- Protect eyes and face from UV rays, heat and sparks using a protective visor and regulation filter
- Wear regulation protective goggles with side protection behind the protective visor
- Wear stout footwear that provides insulation even in wet conditions
- Protect the hands with suitable gloves (electrically insulated and providing protection against heat)
- Wear ear protection to reduce the harmful effects of noise and to prevent injury

---

Keep all persons, especially children, out of the working area while any devices are in operation or welding is in progress. If, however, there are people in the vicinity:

- Make them aware of all the dangers (risk of dazzling by the arc, injury from flying sparks, harmful welding fumes, noise, possible risks from mains current and welding current, etc.)
- Provide suitable protective equipment
- Alternatively, erect suitable safety screens/curtains.

---

**Noise emission values**

The device generates a maximum sound power level of <80 dB(A) (ref. 1pW) when idling and in the cooling phase following operation at the maximum permissible operating point under maximum rated load conditions according to EN 60974-1.

---

It is not possible to provide a workplace-related emission value during welding (or cutting) as this is influenced by both the process and the environment. All manner of different welding parameters come into play, including the welding process (MIG/MAG, TIG welding), the type of power selected (DC or AC), the power range, the type of weld metal, the resonance characteristics of the workpiece, the workplace environment, etc.

---

**Danger from toxic gases and vapours**

The fumes produced during welding contain harmful gases and vapours.

---

Welding fumes contain substances that cause cancer, as stated in Monograph 118 of the International Agency for Research on Cancer.

---

Use at-source extraction and a room extraction system.  
If necessary, use a welding torch with an integrated extraction device.

---

Keep your face away from welding fumes and gases.

Fumes and hazardous gases

- must not be breathed in
- must be extracted from the working area using appropriate methods.

Ensure an adequate supply of fresh air. Ensure that there is a ventilation rate of at least 20 m<sup>3</sup> per hour at all times.

Otherwise, a welding helmet with an air supply must be worn.

If there is any doubt about whether the extraction capacity is sufficient, the measured toxic emission values should be compared with the permissible limit values.

The following components are responsible, amongst other things, for the degree of toxicity of welding fumes:

- Metals used for the workpiece
- Electrodes
- Coatings
- Cleaners, degreasers, etc.
- Welding process used

The relevant material safety data sheets and manufacturer's specifications for the listed components should therefore be studied carefully.

Recommendations for trade fair scenarios, risk management measures and for identifying working conditions can be found on the European Welding Association website under Health & Safety (<https://european-welding.org>).

Flammable vapours (e.g. solvent fumes) should be kept away from the arc's radiation area.

Close the shielding gas cylinder valve or main gas supply if no welding is taking place.

### **Danger from flying sparks**

Flying sparks may cause fires or explosions.

Never weld close to flammable materials.

Flammable materials must be at least 11 metres (36 ft. 1.07 in.) away from the arc, or alternatively covered with an approved cover.

A suitable, tested fire extinguisher must be available and ready for use.

Sparks and pieces of hot metal may also get into adjacent areas through small gaps or openings. Take appropriate precautions to prevent any danger of injury or fire.

Welding must not be performed in areas that are subject to fire or explosion or near sealed tanks, vessels or pipes unless these have been prepared in accordance with the relevant national and international standards.

Do not carry out welding on containers that are being or have been used to store gases, propellants, mineral oils or similar products. Residues pose an explosive hazard.

### **Dangers from welding current**

An electric shock is potentially life threatening and can be fatal.

Do not touch live parts either inside or outside the device.

Make sure that you and others are protected with an adequately insulated, dry temporary backing or cover for the earth or ground potential. This temporary backing or cover must extend over the entire area between the body and the earth or ground potential.

---

All cables and leads must be secured, undamaged, insulated and adequately dimensioned. Loose connections, scorched, damaged or inadequately dimensioned cables and leads must be replaced immediately.

---

Do not sling cables or leads around the body or parts of the body.

---

The electrode (rod electrode, tungsten electrode, welding wire, etc.) must

- never be immersed in liquid for cooling
- never be touched when the power source is switched on.

---

Double the open circuit voltage of a power source can occur between the welding electrodes of two power sources. Touching the potentials of both electrodes at the same time may be fatal under certain circumstances.

---

If necessary, provide an adequate earthing connection for the workpiece.

---

Switch off unused devices.

---

## **Dangers from the battery**

The substances contained in the battery used in this device can be harmful to the environment and to human and animal health.

If the device becomes damaged, please observe the following points:

- Make sure that leaking fluids cannot get into the soil or groundwater
  - If pollution has already occurred, it must be removed in accordance with relevant national regulations
- 

Liquid may leak from the battery if used or stored under improper conditions.

- The liquid may cause irritation or burns.
  - Avoid contact with this liquid.
  - In case of accidental contact, clean the affected area immediately with water.
  - In case of eye contact, also consult a doctor.
- 

The battery can catch fire if overheated. Do not expose the device to heat (e.g. a permanent heat source or fire)

---

If the battery is damaged or subjected to improper use, dangerous vapours may be given off which can irritate the airways.

If this happens:

- Ensure an adequate supply of fresh air
  - Seek medical attention in case of discomfort
- 

With a faulty battery, liquid may leak out of the device.

- Avoid contact with the liquid
  - Hand the device over to a Fronius Service Partner for repair
  - Clean and check any parts that have come into contact with the liquid
- 

Do not operate or store the device in a potentially explosive atmosphere.

Special regulations apply in rooms at risk of fire or explosion.

Observe relevant national and international regulations.

---

To comply with European Directive 2006/66/EC on batteries and accumulators and its implementation in national law, batteries and rechargeable batteries that have reached the end of their life must be collected separately and returned to an approved recycling facility. Be sure to return any device that you no longer require to your distributor, or find out about the approved collection and recycling

facilities in your area. Ignoring this European Directive may have potentially adverse effects on the environment and your health!

---

Devices with mechanically undamaged rechargeable batteries may be returned to the relevant Fronius Service Partner for repair or battery replacement.

As soon as it becomes evident that the rechargeable battery has been mechanically damaged (e.g. electrolyte is escaping), dispose of the device at your nearest recycling centre in accordance with national laws and guidelines.

If anything is unclear or you have any questions about disposal, contact your Fronius Service Partner.

---

Use only the "ActiveCharger 1000" battery charger to charge the power source. Use of a different charger poses a fire risk.

Only operate the power source using the battery provided. Use of a different battery could result in the risk of injury and/or fire.

If the battery is disconnected, keep it away from metal objects such as paper-clips, coins, keys, nails, screws or other small metal objects that could establish a connection between the battery terminals. Short circuiting of the battery poles could result in a burn injury or a fire.

Do not use damaged or modified batteries and power sources. Damaged or modified components and devices may exhibit unpredictable behaviour that could result in an explosion or injury.

Do not expose the power source and the battery to fire or temperatures exceeding 130 °C (266 °F). This could result in an explosion.

Follow the charging instructions contained in these Operating Instructions. Do not charge the battery outside of the permitted temperature range - see section **Environmental conditions** on page 20. Improper charging or exposure to unauthorised temperatures could damage the battery and increase the risk of fire.

---

### Meandering welding currents

---

If the following instructions are ignored, meandering welding currents can develop with the following consequences:

- Fire hazard
- Overheating of parts connected to the workpiece
- Irreparable damage to ground conductors
- Damage to device and other electrical equipment

---

Ensure that the workpiece is held securely by the workpiece clamp.

---

Attach the workpiece clamp as close as possible to the area that is to be welded.

---

If the floor is electrically conductive, the device must be set up with sufficient insulating material to insulate it from the floor.

---

If distribution boards, twin-head mounts, etc., are being used, note the following: The electrode of the welding torch / electrode holder that is not used is also live. Make sure that the welding torch / electrode holder that is not used is kept sufficiently insulated.

---

### EMC measures

In certain cases, even though a device complies with the standard limit values for emissions, it may affect the application area for which it was designed (e.g. when

there is sensitive equipment at the same location, or if the site where the device is installed is close to either radio or television receivers).  
If this is the case, then the operator is obliged to take appropriate action to rectify the situation.

---

Check and evaluate the immunity to interference of nearby devices according to national and international regulations. Examples of equipment that may be susceptible to interference from the device include:

- Safety devices
- Network, signal and data transfer lines
- IT and telecommunications devices
- Measuring and calibrating devices

---

Supporting measures for avoidance of EMC problems:

1. Mains supply
  - If electromagnetic interference arises despite the correct mains connection, additional measures are necessary (e.g. use of a suitable line filter)
2. Welding power-leads
  - must be kept as short as possible
  - must be laid close together (to avoid EMF problems)
  - must be kept well apart from other leads
3. Equipotential bonding
4. Earthing of the workpiece
  - If necessary, establish an earth connection using suitable capacitors.
5. Shield, if necessary
  - Shield other devices nearby
  - Shield the entire welding installation

---

#### **EMF measures**

Electromagnetic fields may pose as yet unknown risks to health:

- Effects on the health of persons in the vicinity, e.g. those with pacemakers and hearing aids
- Individuals with pacemakers must seek advice from their doctor before approaching the device or any welding that is in progress
- For safety reasons, maintain as large a distance as possible between the welding power-leads and the head/torso of the welder
- Do not carry welding power-leads and hosepacks over the shoulders or wind them around any part of the body

---

#### **Requirement for the shielding gas**

Especially with ring lines, contaminated shielding gas can cause damage to equipment and reduce welding quality.

Meet the following requirements regarding shielding gas quality:

- Solid particle size < 40 µm
- Pressure condensation point < -20 °C
- Max. oil content < 25 mg/m<sup>3</sup>

---

Use filters if necessary.

---

---

#### **Danger from shielding gas cylinders**

Shielding gas cylinders contain gas under pressure and can explode if damaged. As the shielding gas cylinders are part of the welding equipment, they must be handled with the greatest of care.

---

Protect shielding gas cylinders containing compressed gas from excessive heat, mechanical impact, slag, naked flames, sparks and arcs.

---

Mount the shielding gas cylinders vertically and secure according to instructions to prevent them falling over.



---

Keep the shielding gas cylinders well away from any welding or other electrical circuits.

---

Never hang a welding torch on a shielding gas cylinder.

---

Never touch a shielding gas cylinder with an electrode.

---

Risk of explosion - never attempt to weld a pressurised shielding gas cylinder.

---

Only use shielding gas cylinders suitable for the application in hand, along with the correct and appropriate accessories (regulator, hoses and fittings). Only use shielding gas cylinders and accessories that are in good condition.

---

Turn your face to one side when opening the valve of a shielding gas cylinder.

---

Close the shielding gas cylinder valve if no welding is taking place.

---

If the shielding gas cylinder is not connected, leave the valve cap in place on the cylinder.

---

The manufacturer's instructions must be observed as well as applicable national and international regulations for shielding gas cylinders and accessories.

---

### **Danger from escaping shielding gas**

Risk of suffocation from the uncontrolled escape of shielding gas

---

Shielding gas is colourless and odourless and, in the event of a leak, can displace the oxygen in the ambient air.

- Ensure an adequate supply of fresh air with a ventilation rate of at least 20 m<sup>3</sup>/hour.
  - Observe safety and maintenance instructions on the shielding gas cylinder or the main gas supply.
  - Close the shielding gas cylinder valve or main gas supply if no welding is taking place.
  - Check the shielding gas cylinder or main gas supply for uncontrolled gas leakage before every start-up.
- 

### **Safety precautions in the place of use and for storage and transport**

A toppling device can cause life-threatening injuries. Place the device on a solid, level surface so that it remains stable

- The maximum permissible tilt angle is 10°.
- 

Do not operate or store the device in a potentially explosive atmosphere.

Special regulations apply in rooms at risk of fire or explosion.

Observe relevant national and international regulations.

---

Use internal directives and checks to ensure that the workplace environment is always clean and clearly laid out.

---

Only set up and operate the device in accordance with the degree of protection shown on the rating plate.

---

When setting up the device, ensure there is an all-round clearance of 0.5 m (1 ft. 7.69 in.) to ensure that cooling air can flow in and out freely.

---

When transporting the device, observe the relevant national and local guidelines and accident prevention regulations. This applies especially to guidelines regarding the risks arising during transport.

---

After transporting the device, it must be visually inspected for damage before commissioning. Any damage must be repaired by trained service technicians before commissioning the device.

---

---

Odourless and colourless shielding gas may escape unnoticed if an adapter is used for the shielding gas connection. Prior to assembly, seal the device-side thread of the adapter for the shielding gas connection using suitable Teflon tape.

---

---

**Safety measures in normal operation**

Only operate the device if all safety devices are fully functional. If the safety devices are not fully functional, there is a risk of

- injury or death to the operator or a third party,
- damage to the device and other material assets belonging to the operator,
- inefficient operation of the device.

---

Any safety devices that are not functioning properly must be repaired before switching on the device.

---

Never bypass or disable safety devices.

---

Before switching on the device, ensure that no one is likely to be endangered.

---

Check the device at least once a week for obvious damage and proper functioning of safety devices.

---

---

**Safety inspection**

The manufacturer recommends that a safety inspection of the device is performed at least once every 12 months.

---

The manufacturer recommends that the power source be calibrated during the same 12-month period.

---

A safety inspection should be carried out by a qualified electrician

- after any changes are made
- after any additional parts are installed, or after any conversions
- after repair, care and maintenance has been carried out
- at least every twelve months.

---

For safety inspections, follow the appropriate national and international standards and directives.

---

Further details on safety inspection and calibration can be obtained from your service centre. They will provide you on request with any documents you may require.

---

---

**Commissioning, maintenance and repair**

It is impossible to guarantee that bought-in parts are designed and manufactured to meet the demands made of them, or that they satisfy safety requirements.

- Use only original spare and wearing parts (also applies to standard parts).
- Do not carry out any modifications, alterations, etc. to the device without the manufacturer's consent.
- Components that are not in perfect condition must be replaced immediately.
- When ordering, please give the exact designation and part number as shown in the spare parts list, as well as the serial number of your device.

---

The housing screws provide the ground conductor connection for earthing the housing parts.

Only use original housing screws in the correct number and tightened to the specified torque.

---

**Safety symbols**

Devices with the CE mark satisfy the essential requirements of the low-voltage and electromagnetic compatibility directives (e.g. relevant product standards of the EN 60 974 series).

Fronius International GmbH hereby declares that the device is compliant with Directive 2014/53/EU. The full text on the EU Declaration of Conformity can be found at the following address: <http://www.fronius.com>

---

Devices marked with the CSA test mark satisfy the requirements of the relevant standards for Canada and the USA.

# Charger

---

## General

The device has been manufactured in line with the state of the art and according to recognized safety standards. If used incorrectly or misused, however, it can cause:

- Serious or fatal injury to the operator or third parties
  - Damage to the device and other material assets belonging to the operating company
  - Inefficient operation of the device
- 

All persons involved in commissioning, operating, maintaining and servicing the device must:

- Be suitably qualified
  - Read and follow these Operating Instructions carefully
- 

The Operating Instructions must always be at hand wherever the device is being used. In addition to the Operating Instructions, attention must also be paid to any generally applicable and local regulations regarding accident prevention and environmental protection.

---

All safety and danger notices on the device:

- Must be kept in a legible state
  - Must not be damaged/marked
  - Must not be removed
  - Must not be covered, pasted, or painted over
- 

For the location of the safety and danger notices on the device, refer to the section headed "General information" in the Operating Instructions for your device. Before switching on the device, rectify any faults that could compromise safety.

**This is for your personal safety!**

---

## Environmental conditions

Operation or storage of the device outside the stipulated area will be deemed as not in accordance with the intended purpose. The manufacturer shall not be held liable for any damage arising from such usage.

---

For exact information on permitted environmental conditions, please refer to the "Technical data" section.

---

## Intended use

The device is to be used exclusively for its intended purpose. Any use above and beyond this purpose is deemed improper. The manufacturer is not liable for any damage, or unexpected or incorrect results arising out of such misuse.

---

Proper use also includes:

- Carefully reading and following all Operating Instructions, safety and danger notices
  - Performing all stipulated inspection and servicing work
  - Following all instructions from the battery and vehicle manufacturers
- 

Proper handling of the device is essential for it to function correctly. Never pull on the cable when handling the device.

---

## Mains connection

Devices with a higher rating may affect the energy quality of the mains due to their current consumption.

---

This may affect a number of device types in terms of:

- Connection restrictions
- Criteria with regard to the maximum permissible mains impedance \*)
- Criteria with regard to the minimum short-circuit power requirement \*)

\*) at the interface with the public grid

see "Technical data"

---

In this case, the plant operator or the person using the device should check whether the device may be connected, where appropriate by discussing the matter with the power supply company.

---

**IMPORTANT!** Ensure that the mains connection is earthed properly

---

### Dangers from mains current and charging current

Anyone working with chargers exposes themselves to numerous dangers e.g.:

- risk of electrocution from mains current and charging current
  - hazardous electromagnetic fields, which can risk the lives of those using cardiac pacemakers
- 

An electric shock can be fatal. Every electric shock is potentially life threatening. To avoid electric shocks while using the charger:

- do not touch any live parts inside or on the outside of the charger.
  - do not short-circuit the charger lead
- 

All cables and leads must be secured, undamaged, insulated and adequately dimensioned. Loose connections, scorched, damaged or inadequately dimensioned cables and leads must be immediately repaired by authorised personnel.

---

### Protecting yourself and others

While the charger is in operation, keep all persons, especially children, out of the working area. If, however, there are people in the vicinity,

- warn them of all the dangers,
  - provide suitable protective equipment.
- 

Before leaving the work area, ensure that people or property cannot come to any harm in your absence.

---

### Safety measures in normal operation

Chargers with a ground conductor must only be operated on a mains supply with a ground conductor and a socket with a ground conductor contact. If the charger is operated on a mains supply without a ground conductor or in a socket without a ground conductor contact, this will be deemed gross negligence. The manufacturer shall not be held liable for any damage arising from such usage.

---

Only operate the charger in accordance with the degree of protection shown on the rating plate.

---

Under no circumstances operate the charger if there is any evidence of damage.

---

Arrange for the mains cable to be checked regularly by a qualified electrician to ensure the ground conductor is functioning properly.

---

Any safety devices and parts that are not functioning properly or are in imperfect condition must be repaired by a qualified technician before switching on the charger.

---

Never bypass or disable protection devices.

---

---

After installation, an accessible mains plug is required.

---

**EMC measures** In certain cases, even though a device complies with the standard limit values for emissions, it may affect the application area for which it was designed (e.g. when there is sensitive equipment at the same location, or if the site where the device is installed is close to either radio or television receivers).  
If this is the case, then the operating company is obliged to take appropriate action to rectify the situation.

---

**Maintenance** Before switching on, always check the mains plug and cable as well as charger leads and charging terminals for any signs of damage.  
If the surface of the device housing is dirty, clean with a soft cloth and solvent-free cleaning agent only.

---

**Maintenance and repair** Maintenance and repair work must only be carried out by authorised personnel. Use only original spare and wearing parts (also applies to standard parts). It is impossible to guarantee that bought-in parts are designed and manufactured to meet the demands made on them, or that they satisfy safety requirements.

---

Modifications, installations or conversions are only permitted with the approval of the manufacturer.

---

**Warranty and liability** The warranty period for the charger is 2 years from the date of invoice. However, the manufacturer will not accept any liability if the damage was caused by one or more of the following:

- Use of the charger "not in accordance with the intended purpose"
- Improper installation and operation.
- Operating the charger with faulty protection devices.
- Non-compliance with the operating instructions.
- Unauthorised modifications to the charger.
- Catastrophes caused by the activities of third parties and force majeure.

---

**Safety inspection** The manufacturer recommends that a safety inspection of the device is performed at least once every 12 months.

---

The safety inspection may only be performed by an appropriately qualified electrician

- After any changes have been made
  - After any additional parts are installed, or after any conversions
  - After repair, care and maintenance are carried out
  - At least every twelve months
- 

For safety inspections, follow the appropriate national and international standards and directives.

---

Further details on safety inspections can be obtained from your service centre. They will provide you on request with any documents you may require.

---

**Markings on the device**

Devices with the CE marking satisfy the essential requirements of the applicable guidelines.

Devices displaying the EAC mark of conformity satisfy the requirements of the relevant standards in Russia, Belarus, Kazakhstan, Armenia and Kyrgyzstan.

**General and electrical risks**

- 1** KEEP THESE INSTRUCTIONS SAFE- This guide contains important safety and Operating Instructions for these charger types (for model, see first page of this document)
- 2** Do not expose the charger to rain or snow
- 3** The use of accessories not sold or recommended by the charger manufacturer can lead to fire, electric shock or personal injury

**Minimum AWG size of an extension cable**

25 ft (7.6 m)	50 ft (15.2 m)	100 ft (30.5 m)	150 ft (45.6 m)
AWG 16	AWG 12	AWG 10	AWG 8

- 4** To reduce the risk of damage to plugs and cables, always unplug the charger by pulling the plug rather than the cable
- 5** Only use an extension cable if it is absolutely necessary. The use of an incorrect extension cable can lead to fire and electric shock. If an extension cable must be used, make sure that
  - The pins of the extension cable plug are of the same number, size and shape as those of the battery charger
  - The extension cable is correctly wired and in good electrical condition
  - The cable size is large enough for the AC amperage of the battery charger, see section **Technical data** on page **80**
- 6** Do not use the battery charger with a damaged cable or plug - replace the cable or plug immediately
- 7** Do not use the battery charger if it has been subjected to heavy impact, dropped or otherwise damaged; hand it over to a qualified service technician
- 8** Do not dismantle the battery charger; hand it over to a qualified service technician if maintenance or repair is required. Incorrect reassembly can result in fire and electric shock
- 9** To reduce the risk of an electric shock, unplug the battery charger from the socket before carrying out any maintenance or cleaning. This risk cannot be reduced by setting controls to the "Off" position





# Power source



## Device concept

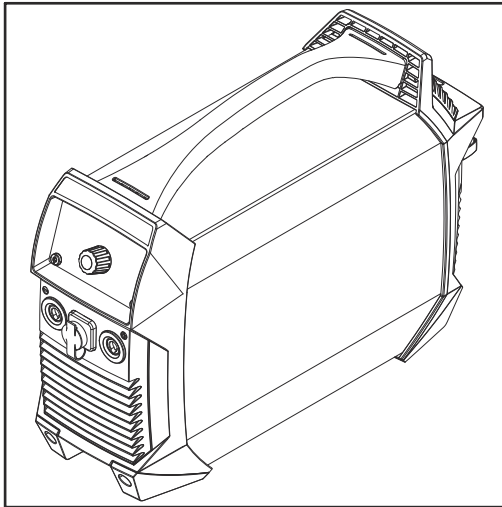

The power source has the following properties:

- Operation without mains electricity
- Compact dimensions
- Robust plastic housing
- Extremely reliable even under harsh operating conditions
- Carrying strap for easy transport on construction sites, etc.
- Protected controls
- Connection sockets with bayonet latch

During welding, an electronic regulator adapts the power source characteristic to suit the welding electrode. The result is a lightweight and compact device with excellent ignition and weld properties.

When cellulose electrodes (CEL) are used, a special operating mode can be selected to ensure perfect welding results.

TIG welding with touchdown ignition greatly extends the range of applications.

## Warning notices on the device

The warning notices and safety symbols on the power source must not be removed or painted over. They warn against incorrect operation which can lead to serious injury and damage.

### Meaning of safety symbols on the device:



Risk of serious injury and damage due to incorrect operation.



Do not use the functions described here until you have fully read and understood the following documents:

- these operating instructions
- all the operating instructions for the system components of the power source, especially the safety rules



Do not dispose of used devices with domestic waste. Dispose of them according to the safety rules.

**Application areas**

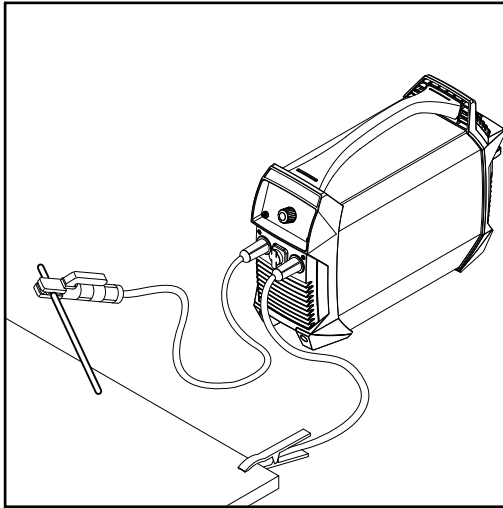

*MMA welding*

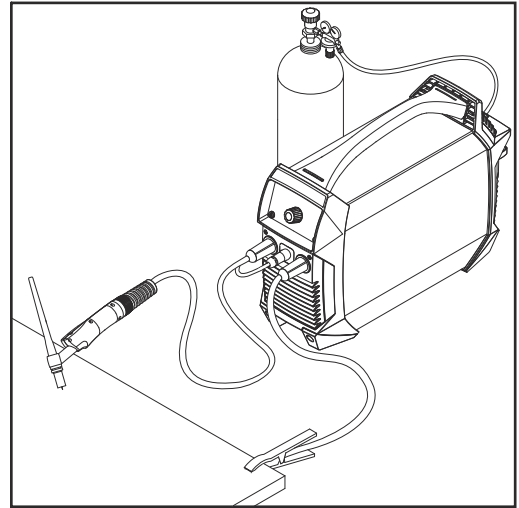

*TIG welding*

# Using rechargeable devices

## Safety

### **WARNING!**

#### **Danger due to improper handling of the lithium-ion battery.**

This can result in severe injury or damage to property.

- ▶ Never expose the power source to naked flames. Excessive heat can cause the battery to explode or burst.
- ▶ Do not open the power source or remove the battery. If the battery becomes damaged due to improper handling, poisonous substances can escape which may be harmful to health.
- ▶ Do not drop the power source into water. This can cause a short circuit, even if the power source is switched off. This in turn can cause the battery to become hot, ignite or burst.

### **WARNING!**

#### **Danger due to incorrect operation and incorrectly performed work.**

This can result in severe injury or damage to property.

- ▶ Do not open the power source.
- ▶ The power source may only be opened by a Fronius service technician.
- ▶ If you need a replacement battery, hand the power source over to a Fronius Service Partner.

## Storage and transport

When storing or transporting the power source, observe the environmental conditions in the [Technical data](#) section from page [66](#).

Particularly if the power source is stored for long periods of time, observe the following points:

- Only store the power source when it is charged. The state of charge should ideally be between 50 and 80%
- Optimum storage temperature: 0 °C to +20 °C (+32 °F to +68 °F)
- Recharge the power source at least every six months

When transporting the power source, observe the relevant national guidelines. Note the following safety data for transport:

- Dangerous goods class: 9
- Classification code: M4
- Packaging group: II

## Service life of the battery

### **NOTE!**

#### **The service life of the battery is dependent entirely upon how it is handled.**

The way in which the battery is operated and stored and the conditions under which this occurs are therefore extremely important.

The intelligent functions of the power source (see section [Battery protection functions](#) from page [31](#)) play a significant role in increasing the service life of the battery.

However, the user must observe the following key points in order to guarantee maximum battery life:

- Recharge the battery after every discharge  
Do not wait until the battery is completely discharged before recharging it.
- Protect the power source from extreme influences
- Optimal environmental conditions for operation:
  - Temperature: +15 °C to +25 °C (+59 °F to +77 °F)
  - Humidity: 50 %
  - Surrounding air is free from dust and corrosive vapours or gases
- Charge power source regularly when not in use
- Check power source at least every 6 months and recharge if necessary

# Battery protection functions

---

## General



The battery protection functions serve to:

- Increase the service life of the battery
  - Protect the battery from long-term damage
  - Ensure the reliability of the power source
- 

## Deep discharge protector

The power source has a deep discharge protector to warn the user if the state of charge of the battery is too low. If this is the case, the power source switches off.

Function of the deep discharge protector:

- When the battery capacity is exhausted
  -  all segments of the battery capacity indicator flash
  -  "Lo" is shown on the display
  - welding is no longer possible
- The power source switches off automatically after three seconds

### CAUTION!

**Danger due to prolonged storage of the battery in a discharged state.**

This can damage the battery.

- ▶ If the deep discharge protector is triggered, charge the power source immediately!
- 

## Automatic switch-off

Automatic switch-off avoids unnecessary power consumption, thereby extending the effective period of operation with one battery charge.

If the power source is not operated for a specific length of time, it switches off automatically.

To reactivate the power source, press the On/Off button for at least two seconds.

### NOTE!

**The factory setting for the automatic switch-off time is 15 minutes (if no welding is performed for 15 minutes, the power source switches off automatically).**

This value can be changed in the Setup menu using the tSd parameter.

---

---

## Temperature monitoring

Temperature monitoring prevents the battery from being charged or discharged if the temperature of the battery is outside the permitted temperature range.

### The battery charger has an internal temperature management function

- From 30 °C: Protection against overheating of the charger by automatic reduction of the power (derating)
- From 45 °C: Only standard charging possible to increase battery life
- From 70 °C: Power source switched off
- Charging is not possible below 0 °C. Welding is conditionally possible depending on the current level.
- Two additional sensors directly on the power module

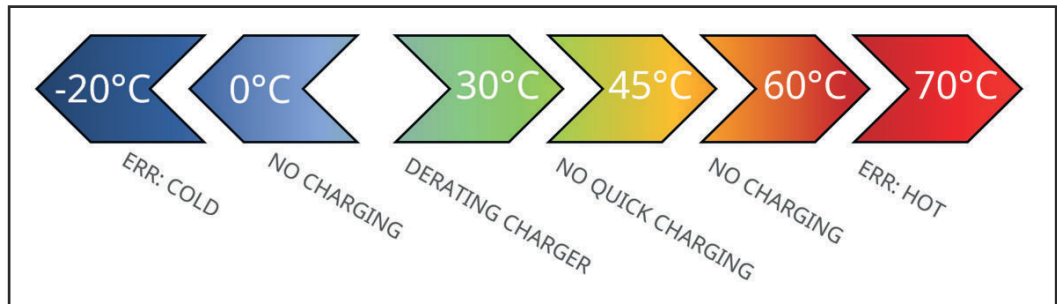

### Undertemperature

If the battery falls below the permitted temperature range, neither welding nor charging is possible.

### Overtemperature

Charging is only possible again at a battery temperature of less than +45 °C.

If the battery exceeds the permitted temperature range:

- the temperature indicator lights up and „hot“ is shown on the display
- neither welding nor charging is possible until the temperature indicator goes out (when the battery has cooled down)

---

## Overcharging protection

Once the battery has been fully charged, the charger turns off automatically and switches to conservation charging mode.

More information on how the battery charger and the individual operating modes work can be found in the charger description on page [69](#).



# Before commissioning

## Safety

### **WARNING!**

#### **Danger from incorrect operation and work that is not carried out properly.**

This can result in serious personal injury and damage to property.

- ▶ All the work and functions described in this document must only be carried out by technically trained and qualified personnel.
- ▶ Read and understand this document in full.
- ▶ Read and understand all safety rules and user documentation for this device and all system components.

## Proper use

The power source is intended exclusively for MMA welding and TIG welding. The integrated battery must only be charged with the Fronius ActiveCharger 1000.

Any other use is deemed improper.

The manufacturer is not liable for damage resulting from such use.

Proper use also includes:

- carefully reading these operating instructions
- following all the instructions and safety rules in these operating instructions
- performing all stipulated inspection and maintenance work

## Setup regulations

### **WARNING!**

#### **Danger from machines toppling over or falling.**

This can result in serious personal injury and damage to property.

- ▶ Set up the device securely on an even, solid surface.
- ▶ Check all screw connections are tightly fastened after installation.

The device is tested to IP 23 protection, meaning:

- Protection against penetration by solid foreign bodies with diameters > 12.5 mm (0.49 in.)
- Protected against spraywater at any angle up to 60° to the vertical

#### **Cooling air**

The device must be set up in such a way that cooling air can flow freely through the slots in the front and rear panels.

#### **Dust**

Ensure that metallic dust is not sucked into the system by the fan, when carrying out grinding for example.

#### **Outdoor operation**

The device can be set up and operated outdoors in accordance with IP23 degree of protection. Avoid direct wetting (e.g. from rain).

## Power connection

The device is designed to be connected to the mains using the Fronius ActiveCharger 1000 only (= hybrid mode, see [Operating modes](#) on page 77).

**NOTE!**

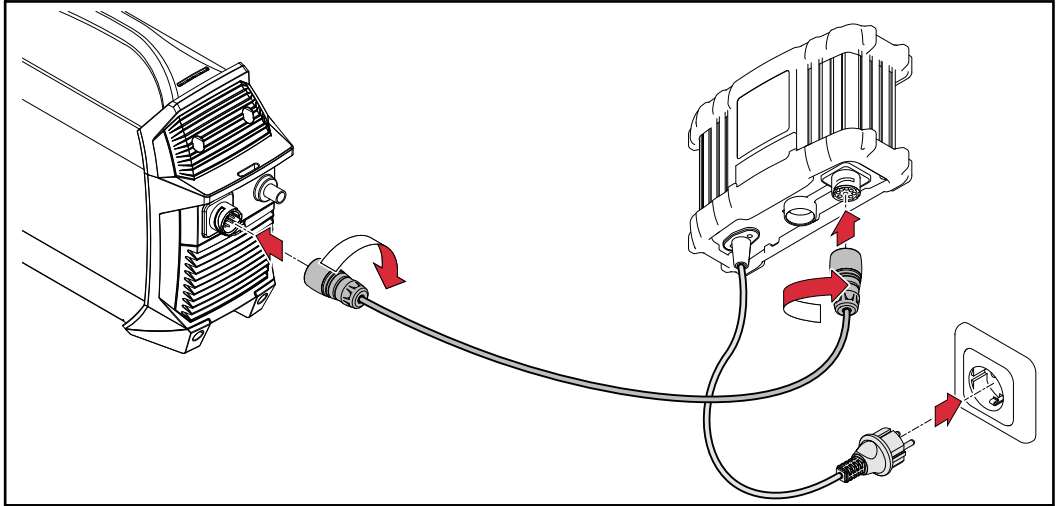

No warranty claims will be entertained if the device is operated with other chargers.

**Before starting  
for the first time**



-  Once connected, the battery capacity indicator on the power source flashes to indicate the current state of charge; the battery is being charged

If the battery is fully charged:

-  The COMPLETED indicator lights up on the charger
-  On the power source, all segments of the battery capacity indicator are lit
- The power source can be put into operation

# Control elements and connections

## Safety

### **WARNING!**

#### **Danger from incorrect operation and work that is not carried out properly.**

This can result in serious personal injury and damage to property.

- ▶ All the work and functions described in this document must only be carried out by technically trained and qualified personnel.
- ▶ Read and understand this document in full.
- ▶ Read and understand all safety rules and user documentation for this device and all system components.

As a result of software updates, you may find that there are functions available on your device that are not described in these Operating Instructions, or vice versa.

Certain illustrations may also differ slightly from the actual controls on your device, but these controls function in exactly the same way.

## Connections and mechanical components

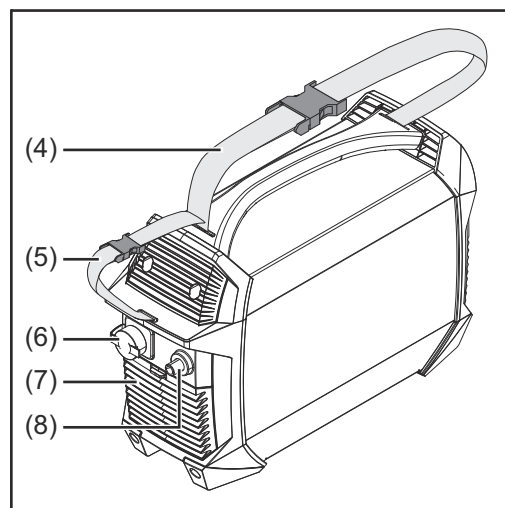
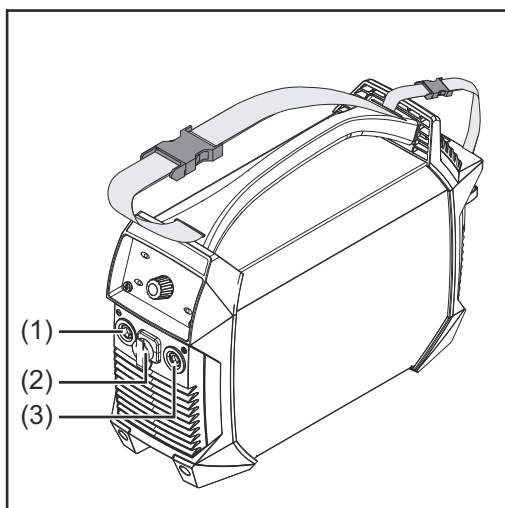

- |            |   |
|------------|---|
| <b>(1)</b> | <b>(-) current socket</b><br>with bayonet latch   |
| <b>(2)</b> | <b>TMC connection (TIG Multi Connector)</b>   |
| <b>(3)</b> | <b>(+) current socket</b><br>with bayonet latch   |
| <b>(4)</b> | <b>Carrying strap</b>   |
| <b>(5)</b> | <b>Cable strap</b><br>for holding the mains cable and the welding power-leads<br>Do not use to move the device! |
| <b>(6)</b> | <b>Charger connection</b>   |
| <b>(7)</b> | <b>Air filter</b>   |
| <b>(8)</b> | <b>Shielding gas connection</b>   |

The use of the current connections depends on the welding process:

- MMA welding (depending on electrode type)
  - (+) current socket** for electrode holder or grounding cable
  - (-) current socket** for electrode holder or grounding cable
- TIG welding
  - (+) current socket** for grounding cable
  - (-) current socket** for welding torch
  - TMC connection** for control connection on the Fronius welding torch

Control panel

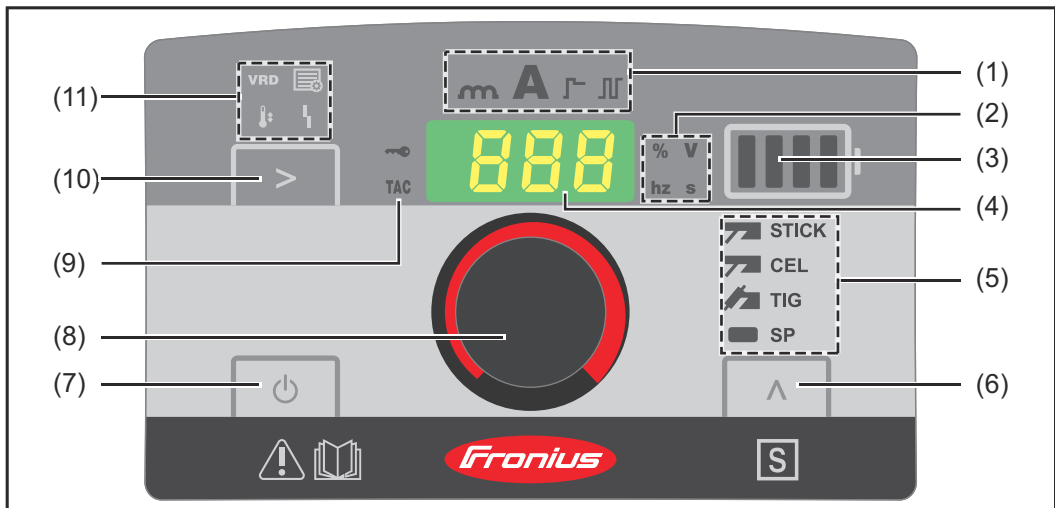

**(1) Setting value indicator**

shows which setting value is selected:

- Arc-force dynamic
- Welding current
- SoftStart / HotStart function
- TIG pulsing / pulse welding

**(2) Unit indicator**

shows the unit of the value that is currently being changed using the adjusting dial (8):

- Percent
- Voltage (volts)
- Frequency (Hertz)
- Time (seconds)

**(3) Battery capacity indicator**

shows the state of charge of the battery:

- Battery fully charged
- Battery capacity 75 %
- Battery capacity 50 %
- Battery capacity 25 %
- Battery discharged **Charge the battery now!**

shows the operating mode:





- lights up in the following situations:
  - in pure welding mode
  - in conservation charging mode
- a bar also flashes in the following operating modes:
  - charging
  - quick charging
  - hybrid mode

**(4) Display**

**(5) Welding process indicator**

shows which welding process is selected:

- STICK MMA welding
- CEL MMA welding with Cel electrode
- TIG TIG welding
- SP reserved for special programs

- 
- (6) **Welding process button**  
for selecting the welding process
- 
- (7) **On/Off button**  
for switching the power source on and off.  
The button must be pressed for at least two seconds before it responds  
(to protect against accidental operation)
- 
- (8) **Adjusting dial**
- 
- (9) **TAC indicator**  
lights up when the tacking function is activated  
(only possible on TIG devices during the TIG welding process)
- 
- (10) **Setting value button**  
for selecting the desired setting value (1)
- 
- (11) **Status indicators**  
display various operating modes of the power source:
-  **VRD** - lights up if the (optional) VRD safety device is present and the reduced safety voltage is present at the welding sockets
  -  **Setup** - lights up in Setup mode
  -  **Temperature** - power source outside the permitted temperature range
  -  **Error** - see also [Troubleshooting](#) from page [61](#)
-

# MMA welding

## Preparatory work



- 1  Press the On/Off button for at least two seconds to turn off the power source
  - the indicators go out
- 2 Plug the grounding cable into the (+) or (-) current socket depending on which type of electrode is to be used and turn it clockwise to latch it in place
- 3 Use the other end of the grounding cable to establish a connection to the workpiece
- 4 Plug the electrode holder into the (+) or (-) current socket depending on which type of electrode is to be used and turn it clockwise to latch it in place
- 5 Insert the rod electrode into the electrode holder

### **WARNING!**







#### **Danger from electrical current.**

This can result in serious personal injury and damage to property.

- ▶ As soon as the power source is switched on, the electrode in the electrode holder is live. Make sure the electrode does not touch any persons or electrically conductive or earthed parts (e.g. the housing, etc.).

- 6  Press the On/Off button for at least two seconds to turn on the power source
  -  the welding current indicator lights up
  - the display shows the specified welding current

## MMA welding

- 1  Use the welding process button to select one of the following processes:
  -  MMA welding - the MMA welding indicator lights up after selection
  -  MMA welding with Cel electrode - the MMA welding with Cel electrode indicator lights up after selection
- 2  Press the setting value button until  the welding current indicator lights up
- 3  Select the amperage using the adjusting dial
  - Power source is ready for welding

## SoftStart / Hot-Start function

This function is used to set the starting current.

**Setting range:** 0 - 200%



#### **Operating principle:**

At the start of the welding process, the welding current is reduced (SoftStart) or increased (HotStart) for 0.5 seconds, depending on the setting.

The change is shown as a percentage from the set welding current.

The duration of the starting current can be changed in the Setup menu using the Hti parameter, see [Parameters for MMA welding](#) on page 50.

### Setting the starting current:









- 1  Press the setting value button until  the SoftStart / HotStart indicator lights up
- 2  Turn the adjusting dial until the desired value is reached
  - Power source is ready for welding

### NOTE!

The maximum HotStart current is limited to 180 A.

### Examples:

(set welding current = 100 A)

- 100%  Starting current = 100 A  Function deactivated
- 80%  Starting current = 80 A  SoftStart
- 135%  Starting current = 135 A  HotStart
- 200%  Starting current = 180 A  HotStart (maximum current limit reached!)

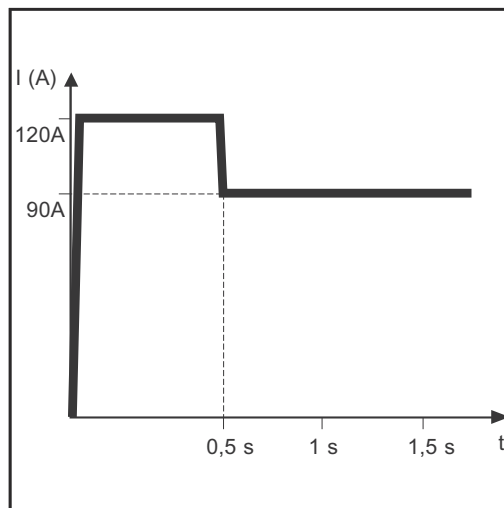

Example of HotStart function

### Features of SoftStart function:

- Reduced pore formation with certain electrode types

### Features of HotStart function:

- Improved ignition properties, even when using electrodes with poor ignition properties
- Better fusion of the base material during the start-up phase, meaning fewer cold-shut defects
- Largely prevents slag inclusions



## Arc-force dynamic

To obtain optimum welding results, it will sometimes be necessary to adjust the arc-force dynamic.



**Setting range:** 0 - 100 (corresponds to 0 - 200 A current increase)

### Operating principle:

At the moment of droplet transfer or in the event of a short circuit, the amperage is briefly increased in order to obtain a stable arc.

If the rod electrode threatens to sink into the weld pool, this measure prevents the weld pool solidifying, as well as preventing a prolonged short-circuit of the arc. This largely prevents the rod electrode from sticking.

### Setting the arc-force dynamic:

- 1  Press the setting value button until  the arc-force dynamic indicator lights up
- 2  Turn the adjusting dial until the desired correction value is reached
  - Power source is ready for welding

### NOTE!

**The maximum arc-force dynamic current is limited to 180 A.**

### Examples:

- Arc-force dynamic = 0
  - arc-force dynamic deactivated
  - soft, low-spatter arc
- Arc-force dynamic = 20
  - arc-force dynamic with 40 A current increase
  - harder, more stable arc
- Set welding current = 100 A / arc-force dynamic = 60
  - arc-force dynamic theoretically with 120 A current increase
  - actual increase is just 80 A as the maximum current limit has been reached!

# TIG modes

## Symbols and their explanations

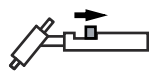

Pull back and hold the torch trigger

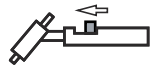

Release the torch trigger forwards



Push forward and hold the torch trigger

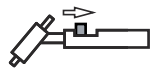

Release the torch trigger backwards

### Adjustable parameters:

- **GPo:** Gas post-flow time
- **I-S:** Starting-current phase - the temperature is raised gently at low welding current, so that the filler metal can be positioned correctly
- **I-E:** Final current phase - to prevent crater cracks or cavitations
- **I-1:** Main current phase (welding-current phase) - uniform thermal input into the base material, whose temperature is raised by the continuous heat
- **I-2:** Reduced current phase - intermediate lowering of the welding current in order to prevent any local overheating of the base material

### Fixed parameters:

- **GPr:** Gas pre-flow time
- **t<sub>up</sub>:** UpSlope phase - the welding current is continually increased  
Duration = 0.5 seconds
- **t<sub>down</sub>:** DownSlope phase - the welding current is continually decreased  
Duration = 0.5 seconds
- **t<sub>S</sub>:** Starting current duration
- **t<sub>E</sub>:** Final current duration

## 2-step mode

See the section on page for details on how to activate 2-step mode.

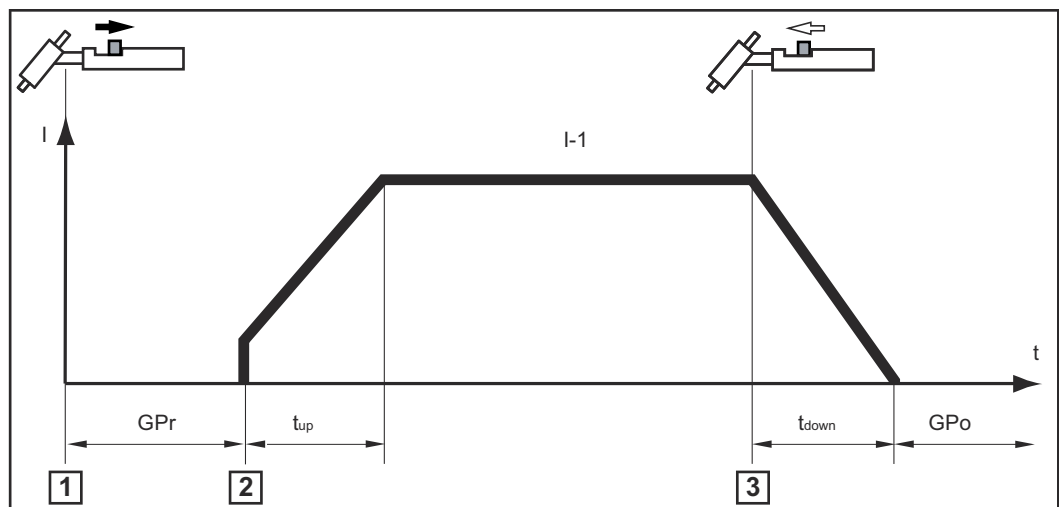

- 1** Place the tungsten electrode onto the workpiece and then pull the torch trigger back and hold => shielding gas flows
- 2** Raise the tungsten electrode => arc ignites

- 3 Release torch trigger => end of welding

**4-step mode**

See the section on page for details on how to activate 4-step mode.

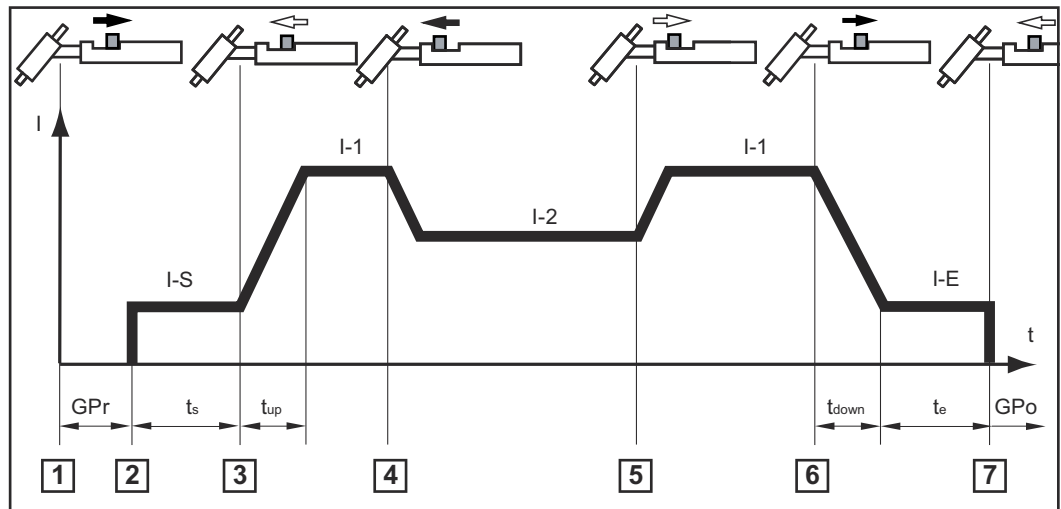

4-step mode with intermediate lowering I-2

Intermediate lowering means that the welder uses the torch trigger during the main current phase to lower the welding current to the specified reduced current I-2.

- 1 Place the tungsten electrode onto the workpiece and then pull the torch trigger back and hold => shielding gas flows
- 2 Raise the tungsten electrode => start of welding with starting current I-S
- 3 Release torch trigger => welding with main current I-1
- 4 Push forward and hold the torch trigger => activation of intermediate lowering with reduced current I-2
- 5 Release torch trigger => welding with main current I-1
- 6 Pull back and hold the torch trigger => lowering to final current I-E
- 7 Release torch trigger => end of welding

# TIG welding

## General

### NOTE!

Do not use pure tungsten electrodes (colour-coded green) if the TIG welding process has been selected.

## Connecting the gas cylinder

### ⚠ WARNING!

#### Danger from falling gas cylinders.

This can result in severe personal injury and damage to property.

- ▶ Place gas cylinders on a solid, level surface so that they remain stable. Secure gas cylinders to prevent them from falling over.
- ▶ Observe the safety rules of the gas cylinder manufacturer.

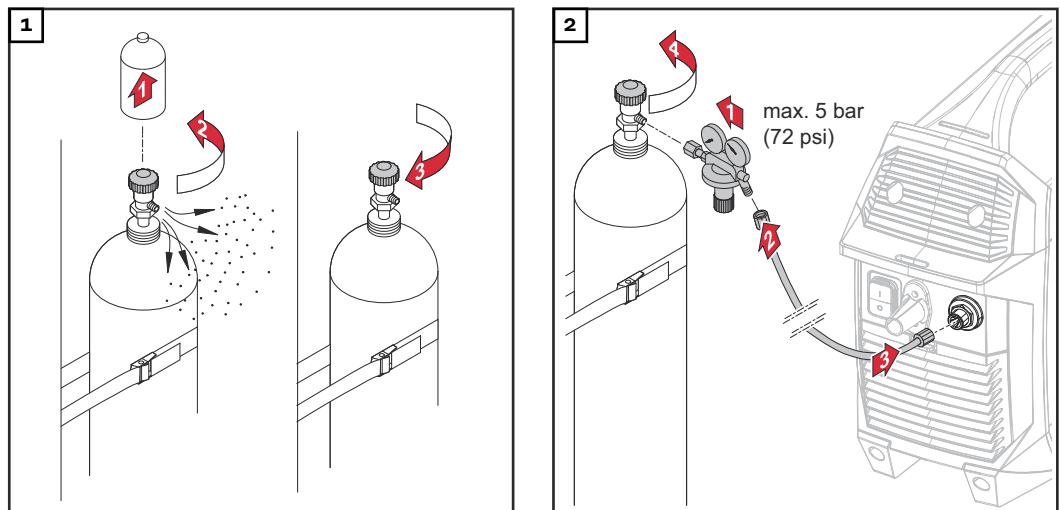

## Preparation

- 1  Press the On/Off button for at least two seconds to turn off the power source  
- the indicators go out
- 2 Plug the TIG welding torch into the (-) current socket and turn it clockwise to latch it in place
- 3 Plug the TIG Multi Connector plug of the TIG welding torch into the TMC connection of the power source
- 4 Set up the welding torch in accordance with the welding torch Operating Instructions
- 5 Plug the grounding cable into the (+) current socket and turn it clockwise to latch it in place



- 6 Use the other end of the grounding cable to establish a connection to the workpiece

**WARNING!**

**Danger from electric shocks.**

This can result in serious injury and damage to property.

- ▶ As soon as the power source is switched on, the electrode in the welding torch is live. Make sure the electrode does not touch any persons or electrically conductive or earthed parts (e.g. the housing, etc.).

- 7  Press the On/Off button for at least two seconds to turn on the power source
-  the welding current indicator lights up
  - the display shows the specified welding current

**Setting the gas pressure**

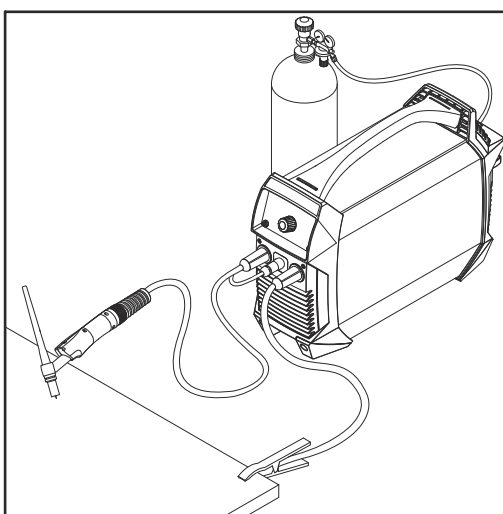

Welding torch with torch trigger  
(and TIG Multi Connector plug)



**Welding torch with torch trigger (and TIG Multi Connector plug):**

- 1 Press the torch trigger  
- shielding gas flows
- 2 Set the desired gas flow rate on the pressure regulator
- 3 Release the torch trigger

**TIG welding**

- 1  Select TIG welding with the welding process button

 the TIG welding indicator lights up

- 2  Press the setting value button until  
 the welding current indicator lights up
- 3  Adjust the welding current using the adjusting dial

**When using a welding torch with a torch trigger and TIG Multi Connector plug (with 2-step mode factory setting):**

- 4 Place the gas nozzle down on the ignition location, ensuring there is a gap of approx. 2 to 3 mm (5/64 to 1/8 in.) between the tungsten electrode and the workpiece Gap exists
- 5 Gradually tilt the welding torch up until the tungsten electrode touches the workpiece
- 6 Pull back and hold the torch trigger  
- Shielding gas flows
- 7 Raise the welding torch and rotate it into its normal position  
- The arc ignites

**8** Carry out welding

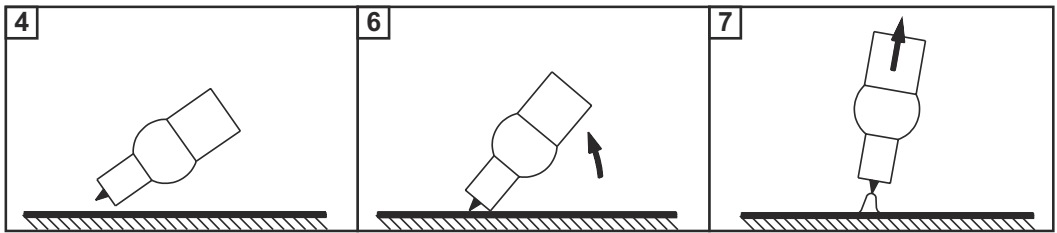

**TIG Comfort Stop**

For more information on activating and setting the TIG Comfort Stop function see [Parameters for TIG welding](#) from page 52.

**Function and application of TIG Comfort Stop:**

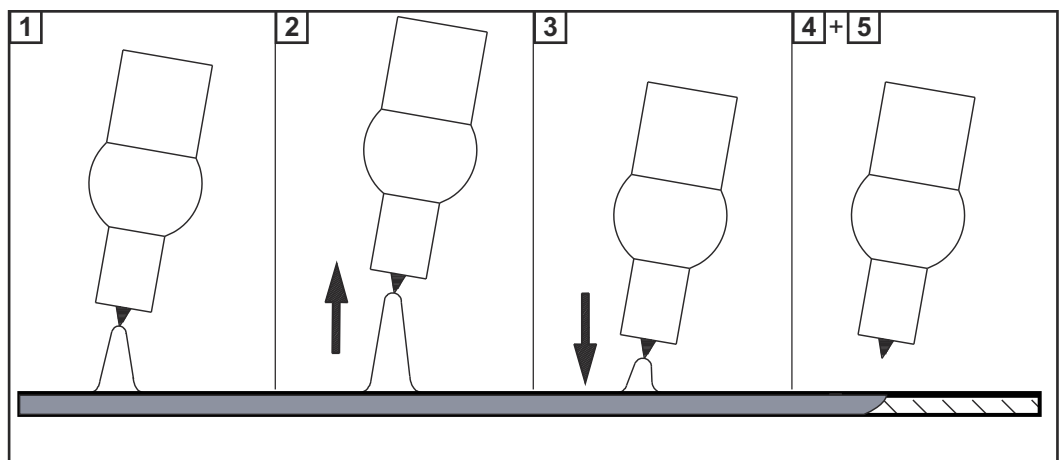

- 1** Welding
- 2** During welding, raise the welding torch
  - The arc length is increased significantly
- 3** Lower the welding torch
  - The arc length is decreased significantly
  - This triggers the TIG Comfort Stop function
- 4** Keep the welding torch at the same height
  - The welding current continually decreases (downslope) until the arc goes out
- 5** Wait for the gas post-flow time to finish and lift the welding torch away from the workpiece

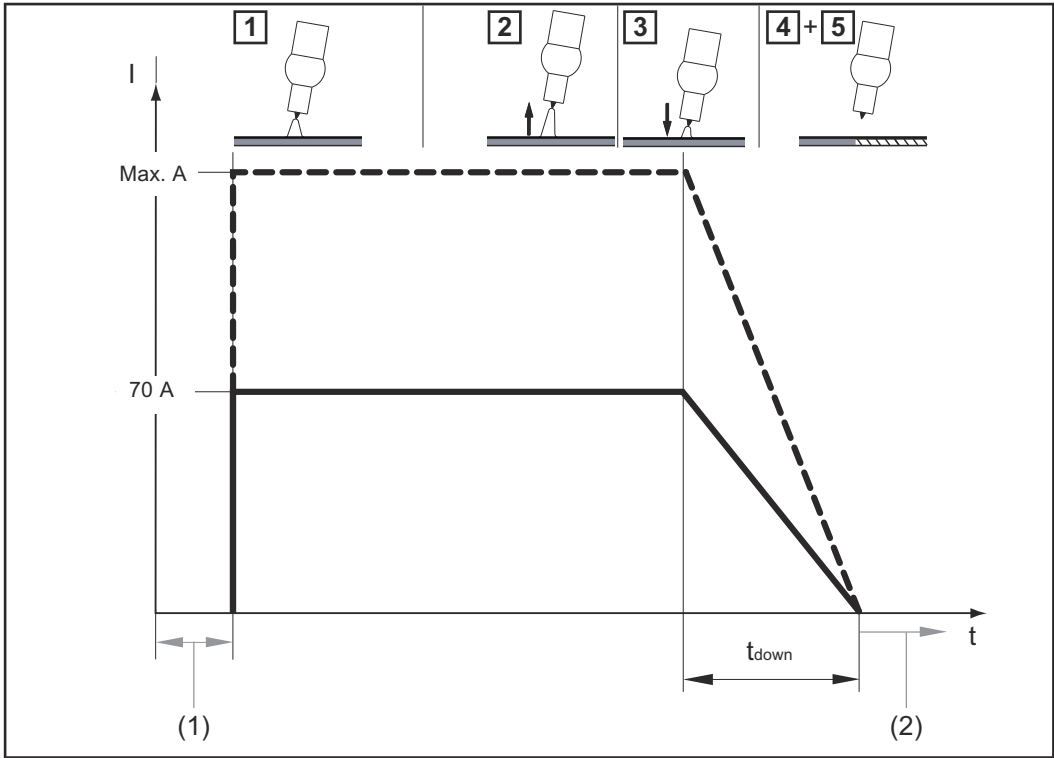

Welding current and gas flow curve with TIG Comfort Stop function activated

- (1) Gas pre-flow
- (2) Gas post-flow

**Downslope:**

The downslope time  $t_{down}$  is 0.5 seconds and cannot be adjusted.

**Gas post-flow:**

The gas post-flow can be changed in the Setup menu via the "GPo" value, see [Parameters for TIG welding](#) on page 52.

## TIG pulsing

TIG pulsing is TIG welding with a pulsing welding current. It is used for out-of-position welding of steel pipes or when welding thin sheets.

In these applications, the welding current set at the start of welding is not always ideal for the whole welding process:

- if the amperage is too low, the base material will not melt sufficiently
- if overheating occurs, the liquid weld pool may drip

**Setting range:** 0.5 - 990 Hz



### Operating principle:

A low base current I-G rises steeply to the significantly higher pulse current I-P and, depending on the set dcY (duty cycle) time, drops back to the base current I-G.

This results in an average for the main current of I-1.

During TIG pulsing, small sections of the welding location melt quickly and then solidify again quickly.

### Activating TIG pulsing / setting the pulse frequency:

- 1  Press the setting value button until  the TIG pulsing indicator lights up
- 2  Turn the adjusting dial until the desired frequency value (Hz) is reached
  - power source is ready for welding

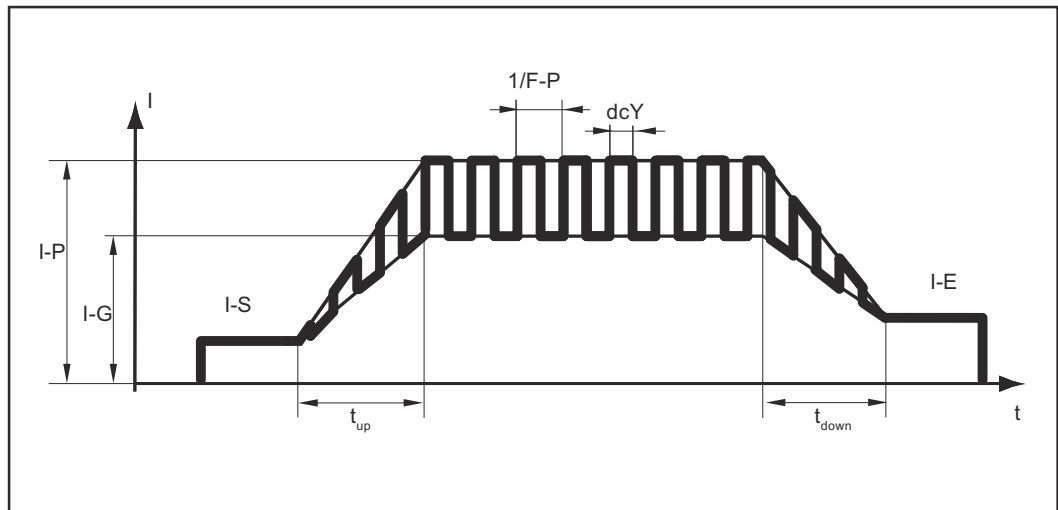

TIG pulsing - welding current curve

### Legend:

I-S	Starting current	I-P	Pulse current
I-E	Final current	F-P	Pulse frequency *)
t <sub>up</sub>	UpSlope	dcY	Duty cycle
t <sub>Down</sub>	DownSlope	I-G	Base current
		I-1	Main current

\*) (1/F-P = time interval between two pulses)



**Tacking function** Activating and setting the tacking function is described in the **Tacking function (tACking)** section on page 53.

The tacking function is only available for the TIG DC welding process.

- When a time period is specified for the tAC (tacking) setup parameter, the tacking function is assigned to all operating modes
- The basic operating sequence of each of these modes remains unchanged
- During the specified period, there is a pulsed welding current that makes the weld pool run together better when two components are being tacked.

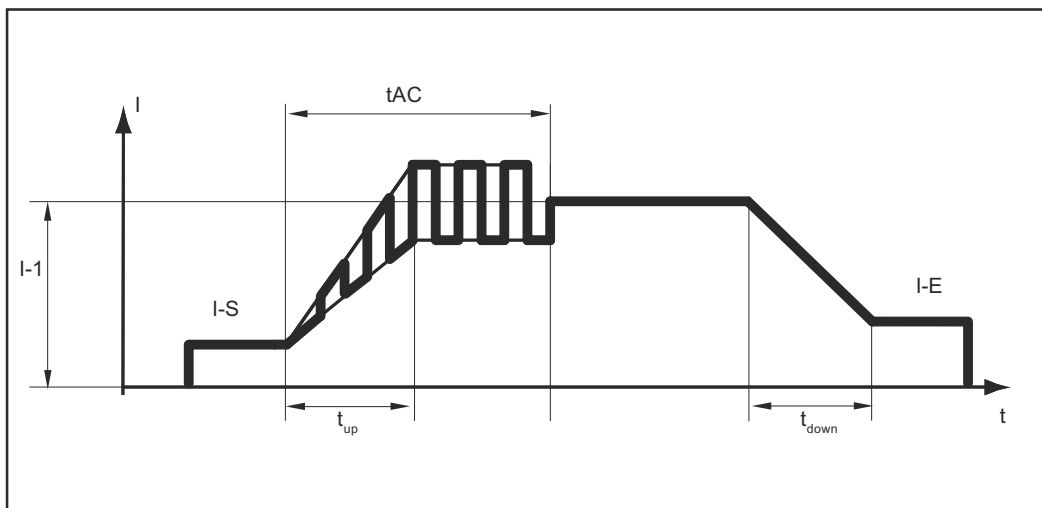

Tacking function - welding current curve

Key:

- tAC Duration of pulsed welding current for the tacking process
- I-S Starting current
- I-E Final current
- $t_{up}$  UpSlope
- $t_{Down}$  Downslope
- I-1 Main current

#### NOTE!

**The following points apply to the pulsed welding current:**

- ▶ The power source automatically regulates the pulsing parameters depending on the specified main current I-1
- ▶ There is no need to set any pulsing parameters

The pulsed welding current begins

- after the end of the starting-current phase I-S
- with the UpSlope phase  $t_{up}$

After the tAC time has elapsed, welding continues at a constant welding current, and any pulsing parameters that may have been set are available.

# The Setup menu

## Accessing the Setup menu

- 1  Use the welding process button to select the process for which the Setup parameters are to be changed:

 MMA welding

 MMA welding with Cel electrode

 TIG welding

---

- MMA welding

 STICK

---

- MMA welding with Cel electrode



 CEL

---

- TIG welding

 TIG

---

- 2  +  Press the setting value and welding process buttons together
  - After releasing the buttons, the code for the first parameter in the Setup menu is displayed

## Changing welding parameters

- 1 Turn the adjusting dial to select the required parameter



- 2 Press the adjusting dial to display the preset value of the parameter





- 3 Turn the adjusting dial to change the value
  - the new value becomes effective immediately
  - exception: when restoring the factory settings, press the adjusting dial after changing the value to activate the new value.



- 4 Press the adjusting dial to return to the list of parameters



## Exiting the Setup menu

- 1  Press the setting value **or**  
 welding process button to exit the Setup menu

## Parameters for MMA welding



**Starting current duration**

0,1 - 1,5 seconds  
for the SoftStart / HotStart function  
Factory setting: 0.5 seconds

**Anti-Stick**

On / OFF

When the anti-stick function is active, the arc is extinguished after 1.5 seconds in the event of a short circuit (sticking of the electrode)

Factory setting: ON (activated)

**Break voltage (U cut off)**

25 - 80 Volts

Used to specify at which arc length the welding process is to be completed.

The welding voltage increases as the length of the arc increases. The arc is extinguished when it reaches the voltage specified here.

Factory setting: 45 volts

**Software version**

The full version number of the currently installed software is spread across a number of displays and can be retrieved by turning the adjusting dial.

**Automatic switch-off (time Shut down)**

300 - 900 Seconds / OFF

If the power source is not operated for the specified length of time, it switches off automatically.

Factory setting: 900 seconds

**Factory setting (FACTory)**

The power source can be reset to its factory settings here.

no / YES / ALL

- Cancel reset
- Reset the parameters for the selected welding process to their factory settings
- Reset the parameters for all welding processes to their factory settings



Resetting of the selected value to its factory setting must be confirmed by pressing the adjusting dial.

---

## Parameters for TIG welding



### Operating mode (trigger mode)

OFF / 2t / 4t

- Operation using welding torch without a torch trigger
- 2-step mode
- 4-step mode

Factory setting: 2t

---



### Starting current (I-Start)

1 - 200 percent

This parameter is only available in 4-step mode (**tri** = 4t).

Factory setting: 50 %

---



### Reduced current

1 - 200 percent

This parameter is only available in 4-step mode (**tri** = 4t).

Factory setting: 50 %

---



### Final current (I-End)

1 - 100 percent

This parameter is only available in 4-step mode (**tri** = 4t).

Factory setting: 50 %

---



### Gas post-flow time (Gas Post flow)

0.2 - 9.9 seconds

Specified period during which gas flows at the end of welding.

Factory setting: 9.9 seconds

---



### Comfort Stop Sensitivity (Comfort Stop Sensitivity)

0.3 - 2.0 V / OFF

This parameter is only available when the **tri** parameter is set to OFF.

Factory setting: OFF

---

For details see the **TIG Comfort Stop** section from page [46](#).

---



**Break voltage (U cut off)**

12 - 35 V

Used to specify at which arc length the welding process is completed. The welding voltage increases as the length of the arc increases. The arc is extinguished when it reaches the voltage specified here.

This parameter is only available when the tri and CSS parameters are set to OFF.

Factory setting: 15 volts

---

**Tacking function (tACking)**

0.1 - 9.9 seconds / OFF

Factory setting: ON

For details see the [Tacking function](#) section on page 49.

---

**Software version**

The full version number of the currently installed software is spread across a number of displays and can be retrieved by turning the adjusting dial.

---

**Automatic shutdown (time Shut down)**

300 - 900 seconds / OFF

If the power source is not operated for the specified length of time, it switches off automatically.

Factory setting: 900 seconds

---

**Factory setting (FACTory)**

no / YES / ALL

The power source can be reset to its factory settings here.

- cancel reset
- reset the parameters for the selected welding process to their factory settings
- reset the parameters for all welding processes to their factory settings



Resetting of the selected value to its factory setting must be confirmed by pressing the adjusting dial.

# VRD safety device (optional)

## General

VRD is an additional safety device that prevents, as far as possible, output voltages that may pose a danger to persons.  
VRD = Voltage Reduction Device.

## Function

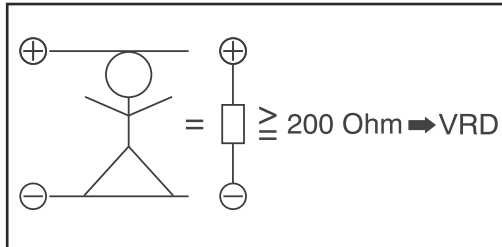

VRD is active

The welding circuit resistance is greater than the minimum human body resistance (greater than or equal to 200 Ohm):

- VRD is active
- Open circuit voltage is limited to 14 V
- **VRD** The VRD indicator lights up
- **Example:** no risk ensues if both welding sockets are touched accidentally at the same time.

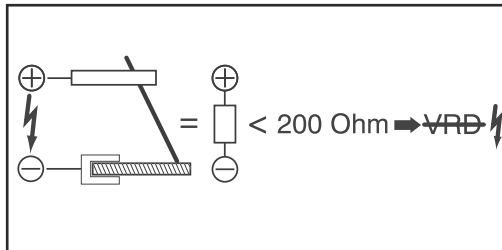

VRD is not active

The welding circuit resistance is less than the minimum human body resistance (less than 200 Ohm):

- VRD is inactive
- Output voltage not limited in order to ensure sufficient welding power
- The VRD indicator does not light up
- **Example:** Start of welding

## NOTE!

### Within 0.

3 seconds of the end of welding:

- ▶ VRD is active again
- ▶ The output voltage is limited to 14 V again

# Care and maintenance

## Safety

### **WARNING!**

#### **Danger from incorrect operation and work that is not carried out properly.**

This can result in serious personal injury and damage to property.

- ▶ All the work and functions described in this document must only be carried out by technically trained and qualified personnel.
- ▶ Read and understand this document in full.
- ▶ Read and understand all safety rules and user documentation for this device and all system components.

### **WARNING!**

#### **Danger from electrical current.**

This can result in serious personal injury and damage to property.

- ▶ Before starting work, switch off all devices and components involved and disconnect them from the grid.
- ▶ Secure all devices and components involved so they cannot be switched back on.
- ▶ After opening the device, use a suitable measuring instrument to check that electrically charged components (such as capacitors) have been discharged.

### **WARNING!**

#### **Danger from incorrect operation and work that is not carried out properly.**

This can result in serious personal injury and damage to property.

- ▶ Do not open the power source. The power source may only be opened by a Fronius service engineer.
- ▶ If you need a replacement battery, hand the power source over to a Fronius Service Partner.

## General

Under normal operating conditions, the device requires only a minimum of care and maintenance. However, it is vital to observe some important points to ensure the device remains in a usable condition for many years.

## At every start-up

- Check the charging lead, welding torch/electrode holder, welding power-lead and grounding (earthing) connection for damage. Replace any damaged components
- Check that there is an all-round clearance of 0.5 m (1 ft. 8 in.) around the power source to ensure that cooling air can flow in and out freely

### **NOTE!**

**Air inlets and outlets must never be covered, not even partially.**

Every 2 months

Clean the air filter (if fitted):

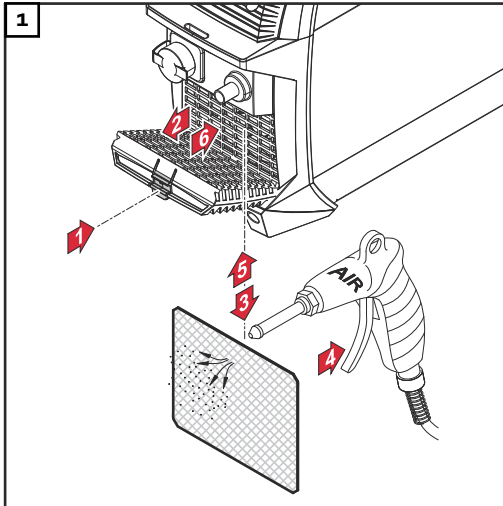



# Disposal

---

## General

Dispose of in accordance with the applicable national and local regulations.

Always dispose of the device separately from the installed battery.

The following section explains how to remove the battery.

---

## Safety



### WARNING!

#### **Danger due to incorrect operation and incorrectly performed work.**

This can result in serious injury and damage to property.

- ▶ All the work and functions described in this document must only be carried out by trained and qualified personnel.
  - ▶ Read and understand this document.
  - ▶ Read and understand all the Operating Instructions for the system components, especially the safety rules.
- 



### WARNING!

#### **Danger from electric current.**

An electric shock can be fatal.

- ▶ Switch off the power source.
  - ▶ Disconnect the power source from the battery charger.
  - ▶ Ensure that the power source remains disconnected from the battery charger until all work has been completed.
  - ▶ After opening the device, use a suitable measuring instrument to check that electrically charged components (such as capacitors) have been discharged.
-

## Removing the re-chargeable battery pack

### NOTE!

The following steps on removing the rechargeable battery pack must only be used when disposing of the device!

- ▶ If the rechargeable battery pack needs to be repaired or replaced, contact After-Sales Service.

### NOTE!

Before removing the rechargeable battery pack, the power source must be disconnected from the battery charger!

- ▶ Ensure that the power source is completely discharged.

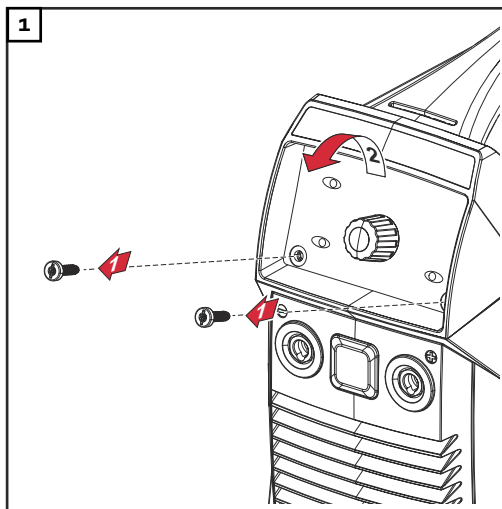

Remove the control panel

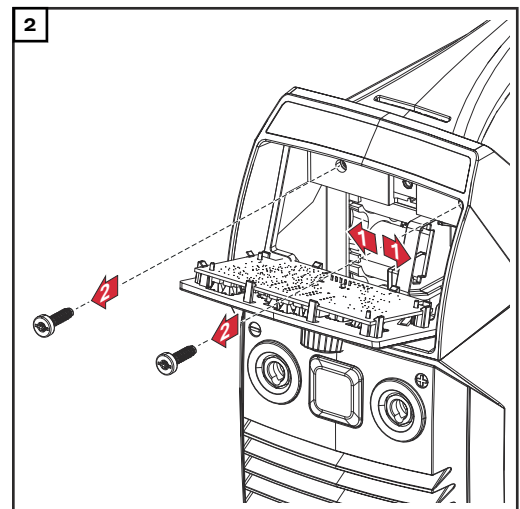

Disconnect the (+) power cable from the rechargeable battery pack, remove 2 TX25 screws

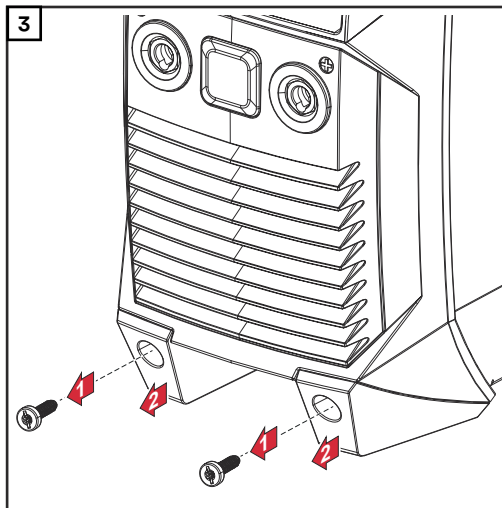

Remove 2 TX25 screws, remove device feet at the front

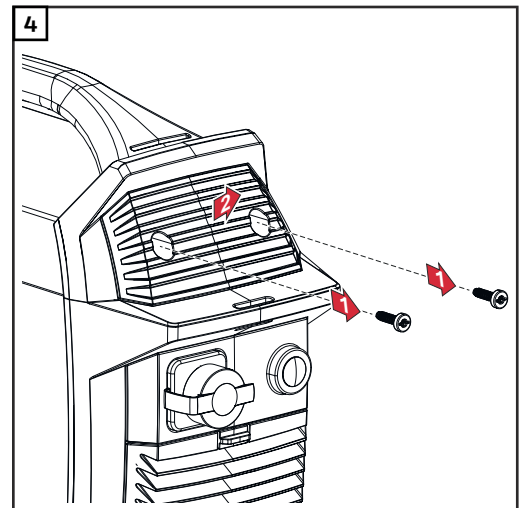

Remove 2 TX25 screws, remove the cover

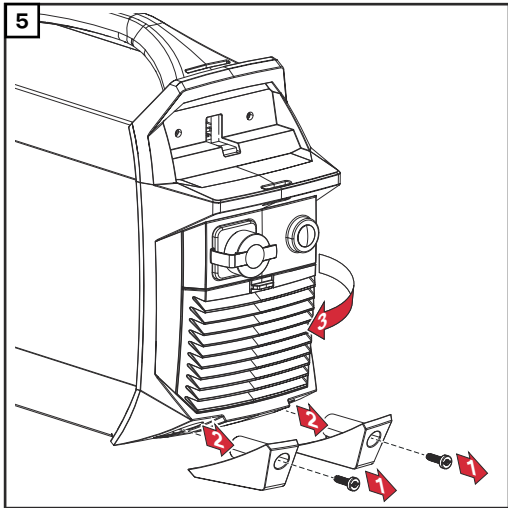

Remove 2 TX25 screws, remove device feet, fold rear to one side

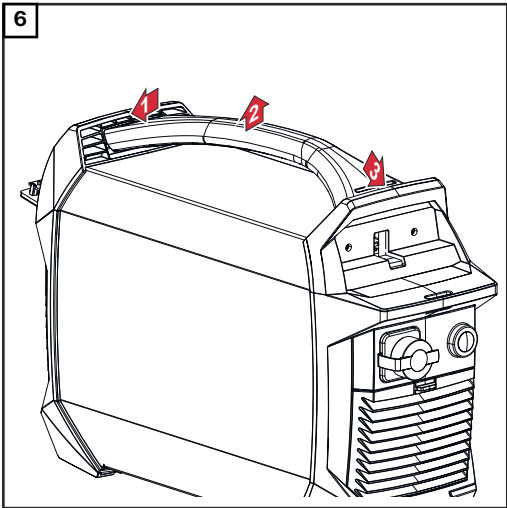

Press front and rear outwards, remove carrying handle

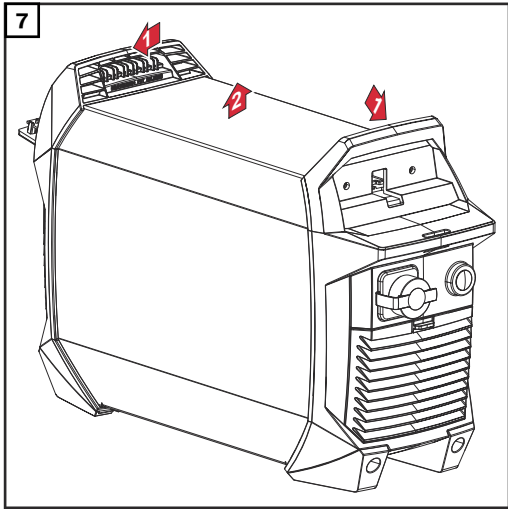

Press front and rear outwards, remove device casing

**⚠ CAUTION!**

**Fire hazard due to short circuit of the battery!**

If the battery is short-circuited, sparks may be generated and the battery may catch fire.

- ▶ After terminating the (-) power cable, insulate it well (e.g. wrap it with insulating tape)!

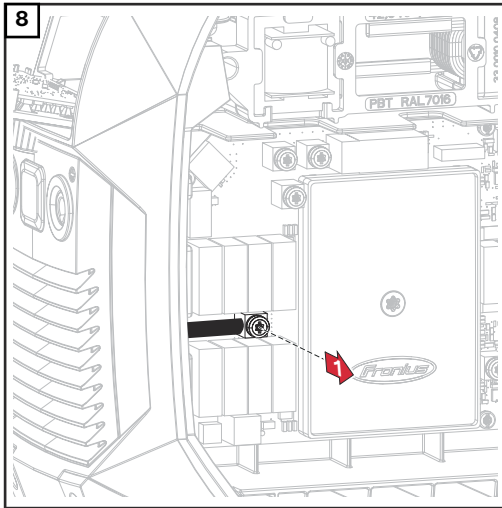

Remove TX25 screw and terminate (-) power cable of the rechargeable battery back;  
**IMPORTANT!** Insulate the terminated cable lug well!!

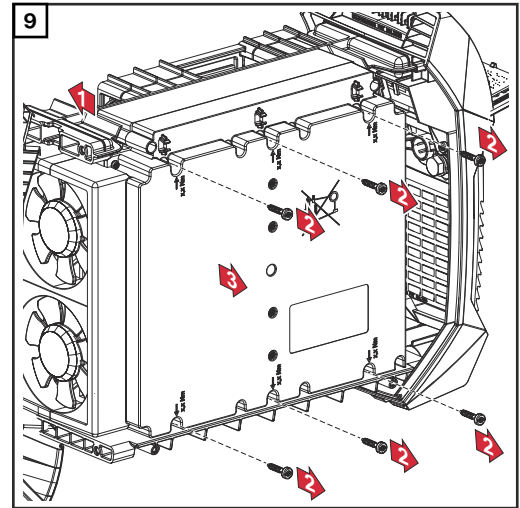

Disconnect 16-pin connector X1 from the battery pack, remove 6 TX 20 screws, remove the rechargeable battery pack

**10** Dispose of the device and rechargeable battery pack separately according to the local guidelines

## Safety

### **WARNING!**

#### **Danger from incorrect operation and work that is not carried out properly.**

This can result in serious personal injury and damage to property.

- ▶ All the work and functions described in this document must only be carried out by technically trained and qualified personnel.
- ▶ Read and understand this document in full.
- ▶ Read and understand all safety rules and user documentation for this device and all system components.

### **WARNING!**

#### **Danger from electrical current.**

This can result in serious personal injury and damage to property.

- ▶ Before starting work, switch off all devices and components involved and disconnect them from the grid.
- ▶ Secure all devices and components involved so they cannot be switched back on.
- ▶ After opening the device, use a suitable measuring instrument to check that electrically charged components (such as capacitors) have been discharged.

### **WARNING!**

#### **Danger from incorrect operation and work that is not carried out properly.**

This can result in serious personal injury and damage to property.

- ▶ Do not open the power source. The power source may only be opened by a Fronius service engineer.
- ▶ If you need a replacement battery, hand the power source over to a Fronius Service Partner.

## Indicated errors

### **Overtemperature**

"hot" appears on the display, the temperature indicator lights up

 + 

Cause: Device is too hot

Remedy: Check/reduce ambient temperature, allow power source to cool down

### **Undertemperature**

"cold" appears as scrolling text on the display, the temperature indicator lights up

 + 

Cause: Device temperature too low

Remedy: Check/increase ambient temperature, operate the power source in a warmer environment

For more information see the [Environmental conditions](#) section on page [66](#)

---

### Deep discharge protector

"Lo" appears in the display, the "Battery capacity" indicator flashes



Cause: Battery discharged, deep discharge protection has been activated

Remedy: Charge the battery now

Battery operation is possible again above 25% capacity

---

### CAUTION!

#### **Danger due to prolonged storage of the battery in a discharged state.**

This can damage the battery.

- ▶ If the deep discharge protector is triggered, charge the power source promptly!
- 
- 

---

### Service messages

When E and a 2 digit error number appear in the display (e.g. E02) and the "Error" indicator lights up, this is an internal power source service code.

**Example:**



It is also possible that several error numbers are present. These appear when turning the adjusting dial.



Make a note of the error numbers shown in the display, and of the serial number and configuration of the power source, and contact our after-sales service team with a detailed description of the error.

---

#### **E02 / E03 / E05 / E06**

Cause: Internal temperature sensor fault on ACCUPLT / ACCUPLT-TIG PC board

Remedy: Contact after-sales service

---

#### **E07 / E72**

Cause: Internal supply voltage 15 V outside the valid range

Remedy: Contact After-Sales Service

---

#### **E09 / E10**

Cause: Load too high on power source current sockets

Remedy: Use power source correctly (welding)

---

#### **E11**

Cause: No communication with the control panel

Remedy: Contact after-sales service

---

#### **E12 / E13 / E14**

Cause: Internal error on ACCUPLT / ACCUPLT-TIG PC board

Remedy: Contact after-sales service

---

**E16**

Cause: Communication error between battery and ACCUPLT / ACCUPLT-TIG PC board

Remedy: Contact after-sales service

---

**E18**

Cause: Wrong firmware (software) has been loaded

Remedy: Contact after-sales service

---

**E19 / E22 / E30 / E53 / E83**

Cause: Battery fault

Remedy: Contact After-Sales Service

---

**E23**

Cause: A voltage of > 113 V DC has been measured on the current sockets

Remedy: Contact After-Sales Service

---



---

**No function**

---

**The power source cannot be switched on**

Cause: The battery has entered a state of deep discharge as it has been stored for too long without being charged

Remedy: Charge the battery now

 Battery operation is possible again above 25% capacity. If charging is no longer possible, contact After-Sales Service.

Cause: Control panel defective

Remedy: Contact After-Sales Service

---

**Battery is not charged**

Power source is connected to the charger, charger is connected to the mains, no charging indicator on the power source

Cause: Device is too hot

Remedy: Check/reduce ambient temperature, allow battery to cool down

Cause: Device temperature too low

Remedy: Check/increase ambient temperature, disconnect and reconnect battery charger

Cause: Charging cable defective

Remedy: Renew charging cable

---

**No welding current**

Power source is switched on, indicator for the selected welding process is lit

Cause: Welding power-lead connections have been disconnected

Remedy: Establish proper welding power-lead connections

Cause: Poor or no earth

Remedy: Establish a connection to the workpiece

Cause: There is a break in the power cable in the welding torch or electrode holder

Remedy: Replace welding torch or electrode holder

---

**No welding current**

Power source is switched on, indicator for the selected welding process is lit, overtemperature indicator lit

Cause: Duty cycle exceeded - power source overloaded - fan running

Remedy: Keep within duty cycle

Cause: Thermostatic automatic circuit breaker has been tripped

Remedy: Wait until the power source comes back on automatically at the end of the cooling phase

Cause: The fan in the power source is faulty

Remedy: Contact After-Sales Service

Cause: Insufficient cooling air intake

Remedy: Ensure adequate air supply

Cause: Air filter is dirty

Remedy: Clean air filter

---

**No welding current**

Power source is switched on, indicator for the selected welding process is lit, overtemperature indicator lit

Cause: Power module error

Remedy: Turn off the power source, then turn it on again.  
If the error occurs frequently, contact After-Sales Service

---

---

**Faulty operation**

---

**Poor ignition properties during MMA welding**

Cause: Incorrect welding process selected

Remedy: Select "MMA welding" or "MMA welding with Cel electrode" process

Cause: Starting current too low; electrode sticking during ignition

Remedy: Increase starting current using HotStart function

Cause: Starting current too high; electrode consumed too quickly during ignition or is generating a lot of spatter

Remedy: Reduce starting current using SoftStart function



---

**In some cases, arc breaks during welding**

Cause: Electrode (e.g. grooved electrode) voltage too high

Remedy: If possible, use alternative electrode or a power source with more welding power

Cause: Comfort Stop Sensitivity (CSS) setting is too sensitive

Remedy: Increase or deactivate the CSS value in the Setup menu

Cause: Break voltage (Uco) set too low

Remedy: Increase break voltage (Uco) in Setup menu

---

**Rod electrode tends to stick**

Cause: Value of arc-force dynamic parameter (MMA welding) set too low

Remedy: Increase value of arc-force dynamic parameter

---

**Poor weld properties**

(severe spattering)

Cause: Incorrect electrode polarity

Remedy: Reverse electrode polarity (refer to manufacturer's instructions)

Cause: Poor grounding (earthing) connection

Remedy: Fasten earthing clamps directly to workpiece

Cause: Setup parameters not ideal for selected welding process

Remedy: Select the optimal settings in the Setup menu for the selected welding process

---

**Tungsten electrode melting**

Tungsten inclusions in base metal during the ignition phase

Cause: Incorrect tungsten electrode polarity

Remedy: Connect the TIG welding torch to the (-) current socket

Cause: Incorrect (or no) shielding gas

Remedy: Use inert shielding gas (argon)

---

**VRD does not light up even though no welding process is taking place**

Cause: VRD option not present  
or internal device fault

Remedy: Contact after-sales service

---

# Technical data

---

## Environmental conditions

---

Transport, storage or operation of the device outside the stipulated range will be deemed improper. The manufacturer shall not be held liable for any damage arising from such usage.

---

Ambient air temperature range:

- During operation: -10 °C to + 40 °C (14 °F to 104 °F)
- During transport: -20 °C to +55 °C (-4 °F to 131 °F)
- Recommended temperature range during charging:  
+ 4 °C to + 40 °C (+ 39.2 °F to + 104 °F)
- Recommended temperature range during storage:  
0 °C to + 20 °C (+ 32 °F to + 68 °F)

When placing in storage, the state of charge should ideally be at 50 - 80% (corresponds to approx. 2 to 3 bars on the charging status indication).

---

Relative humidity:

- Up to 50% at 40 °C (104 °F)
  - Up to 90 % at 20 °C (68 °F)
- 

The surrounding air must be free from dust, acids, corrosive gases or substances, etc.

Can be used at altitudes up to 2000 m (6561 ft.)

---

---

## Explanation of the term "duty cycle"

Duty cycle (ED) is the proportion of time in a 10-minute cycle at which the device may be operated at its rated output without overheating.

### **NOTE!**

**The ED values specified on the rating plate are based on an ambient temperature of 40 °C.**

If the ambient temperature is higher, either the ED or output must be reduced accordingly.

---

Example: Welding at 150 A at 60% ED

- Welding phase = 60% of 10 minutes = 6 minutes
- Cooling phase = remaining time = 4 minutes
- After the cooling phase, the cycle begins again.

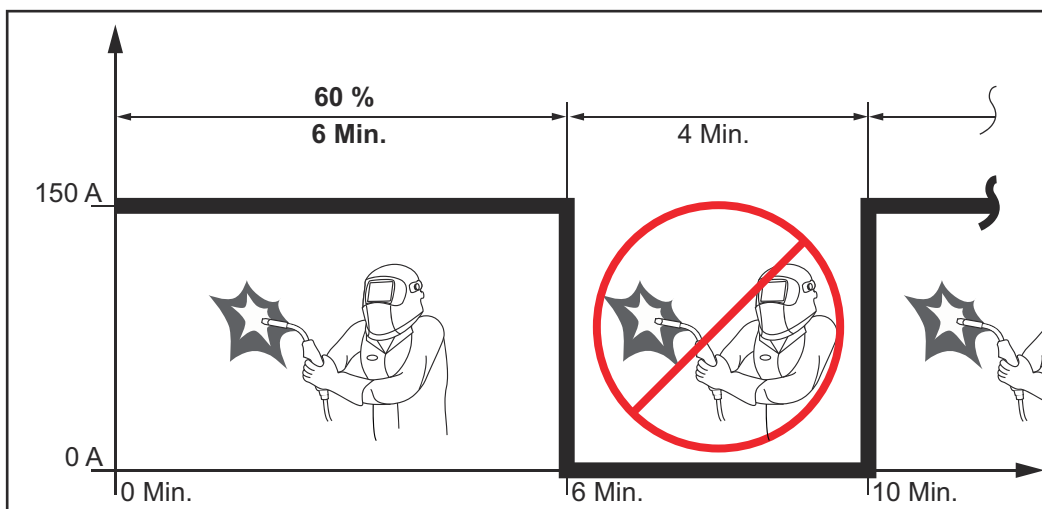

If the device is to be continuously operated without stopping:

- 1** Look in the technical data for a ED value of 100% for the current ambient temperature.
- 2** Reduce the output or amperage in line with this value so that the device can remain in use without observing a cooling phase.

## Technical data

Rated battery voltage			50.4 V
Charging current			10 A
Rapid charging current			18 A
Battery capacity			15 Ah
Battery type			Li-ion
Standard charging			90 min.
Rapid charging			50 min.
Weld time	Ø 2.5 mm	Electrode	21 - 27 pcs
	Ø 3.25 mm	Electrode	9 - 12 pcs
Welding current range	Electrode DC		10 - 150 A
	TIG DC		3 - 150 A
Welding current in hybrid mode (manual metal arc welding)			
	40 °C (104 °F)	18 % D.C. <sup>1)</sup>	150 A
	40 °C (104 °F)	25 % D.C. <sup>1)</sup>	100 A
	40 °C (104 °F)	100 % D.C. <sup>1)</sup>	40 A
Welding current in hybrid mode (TIG welding)			
	40 °C (104 °F)	25 % D.C. <sup>1)</sup>	150 A
	40 °C (104 °F)	50 % D.C. <sup>1)</sup>	100 A
	40 °C (104 °F)	100 % D.C. <sup>1)</sup>	65 A
Open circuit voltage			91 V
Reduced open circuit voltage (only with VRD option)			14 V

Protection class	IP 23
Type of cooling	AF
Dimensions L x W x H	435 x 160 x 310 mm 17.1 x 6.3 x 12.2 in.
Weight	11.4 kg (25.1 lb)
Max. shielding gas pressure	5 bar (72 psi)

<sup>1)</sup> D.C. = Duty cycle

# Charger



## Warning notices on the device

A number of safety symbols can be seen on the charger's rating plate. The safety symbols must not be removed or painted over.

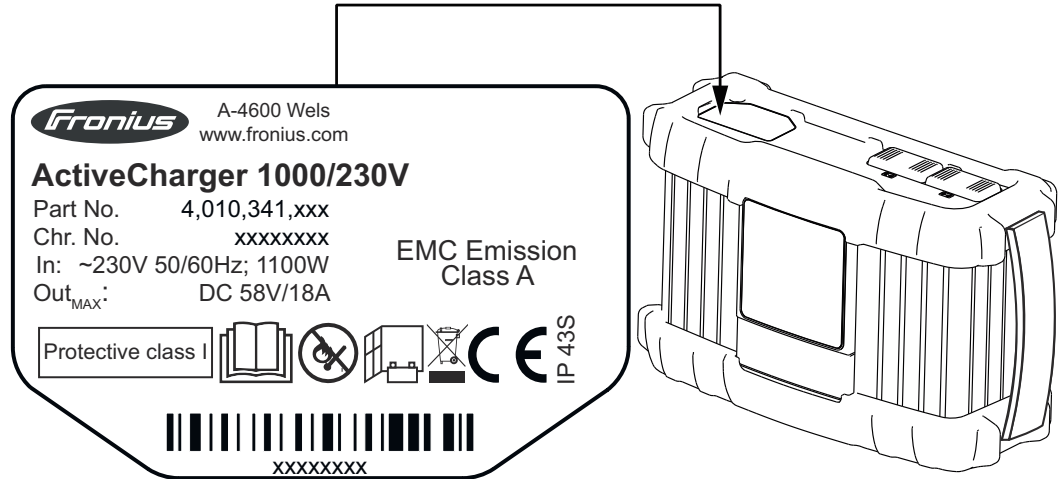

Do not use the functions described here until you have fully read and understood the following documents:

- these operating instructions
- all the operating instructions for the system components of the power source, especially the safety rules



Possible sources of ignition, such as fire, sparks and naked flames, must be kept away from the battery.



Ensure an adequate supply of fresh air during charging. Maintain a distance of at least 0.5 m (19.69 in.) between battery and charger during the charging procedure.



Do not dispose of used devices with domestic waste. Dispose of them according to the safety rules.

---

**Warning notices  
inside the device**



An electric shock can be fatal. Do not open the device!

The housing must never be opened by anyone other than a Fronius-trained service engineer. The device must be disconnected from the mains before starting any work with the housing open. A suitable measuring instrument must be used to ensure that electrically charged components (e.g. capacitors) are fully discharged. Ensure that the device remains disconnected from the mains until all work has been completed.

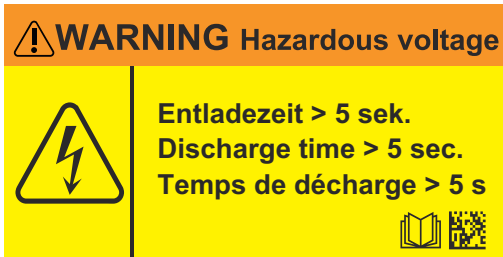

This warning sign is located inside the device. It must NOT be removed or painted over.

The discharge time of the capacitors is approx. one minute.

---

**Intended use**

The charger is designed to charge the power sources listed below. Any use above and beyond this purpose is deemed improper. The manufacturer shall not be liable for any damage resulting from such use. Proper use also includes:

- Carefully reading these Operating Instructions
- Following all the instructions and safety rules in these Operating Instructions

---

**⚠ WARNING!**

**Charging any other devices can cause serious injury or damage, and is therefore prohibited.**

---

The following power sources may be charged:

- Fronius AccuPocket 150/400
- Fronius AccuPocket 150/400 TIG
- Fronius Ignis 150 B /750

The charger is intended solely for commercial use.



# Before commissioning

## Mains connection

The rating plate, which is located on the housing, contains information about the permitted mains voltage. The device is designed for this mains voltage only. For details on the required fuse protection for the mains lead, see the [Technical data](#) section on page 80. If there is no mains cable or mains plug on your version of the appliance, fit one that conforms to national standards.

### CAUTION!

#### **Danger due to insufficiently dimensioned electrical installations.**

This can result in serious damage to property.

- ▶ The mains lead and its fuse must be dimensioned to suit the local power supply.
- ▶ Read the technical data on the rating plate.

## Generator-powered operation

The charger is completely generator-compatible, provided the maximum apparent power delivered by the generator is at least 2 kVA. This also applies if the generator in question is an inverter.

### **NOTE!**

**The voltage delivered by the generator must never exceed the upper or lower limits of the mains voltage tolerance range.**

Details on the mains voltage tolerance can be found in the [Technical data](#) section on page 80.

## Setup regulations

### WARNING!

#### **Danger from machines toppling over or falling.**

This can result in serious personal injury and damage to property.

- ▶ Set up the device securely on an even, solid surface.
- ▶ Check all screw connections are tightly fastened after installation.

The device is tested to IP40 protection, meaning:

- Protection against penetration by solid foreign bodies with diameters > 1.0 mm (0.04 in.)
- Protection against spraywater at any angle up to 60° to the vertical when fan is not running.

#### **Dust**

Ensure that metallic dust is not sucked into the system by the fan, when carrying out grinding for example.

#### **Outdoor operation**

The device can be set up and operated outdoors in accordance with IP40 degree of protection. Avoid direct wetting (e.g. from rain).

**Space requirements**

If the charger is installed in a switch cabinet (or a similar sealed area), then forced-air ventilation must be provided to ensure adequate heat dissipation. There should be an all-round clearance of 10 cm (3.9 in.) around the charger.

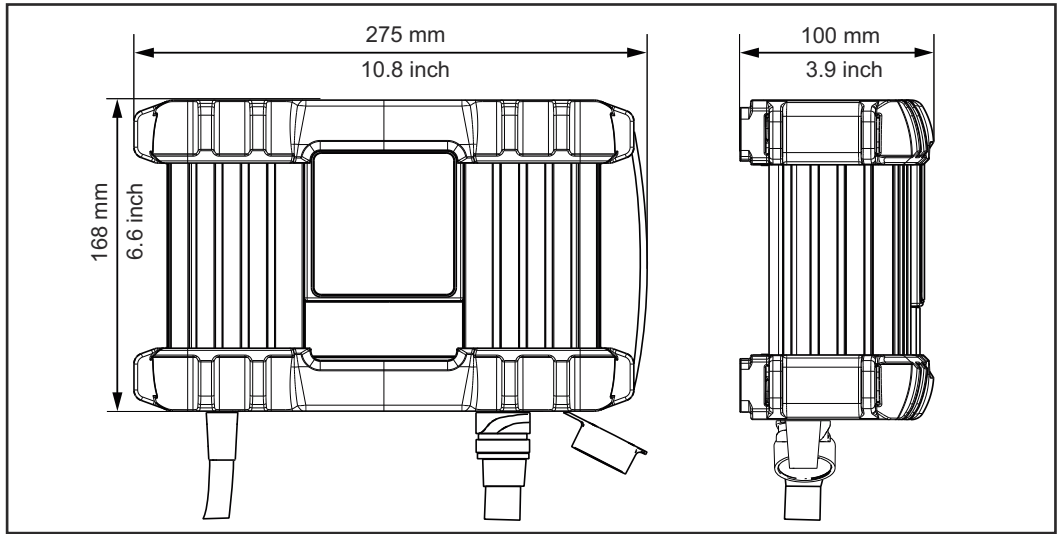

# Control elements and connections

## Safety

### **WARNING!**

#### **Danger from incorrect operation and work that is not carried out properly.**

This can result in serious personal injury and damage to property.

- ▶ All the work and functions described in this document must only be carried out by technically trained and qualified personnel.
- ▶ Read and understand this document in full.
- ▶ Read and understand all safety rules and user documentation for this device and all system components.

As a result of software updates, you may find that there are functions available on your device that are not described in these Operating Instructions, or vice versa.

Certain illustrations may also differ slightly from the actual controls on your device, but these controls function in exactly the same way.

## Connections and components

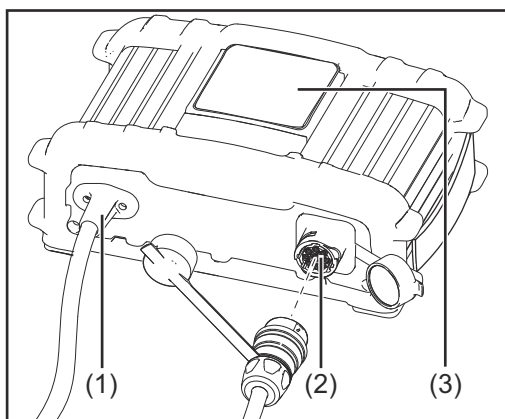

- (1) **Mains cable**  
for connection to the mains
- (2) **Connection P1 - charging lead socket**  
to plug in the charging cable for connection to the power source
- (3) **Control panel**

## Control panel

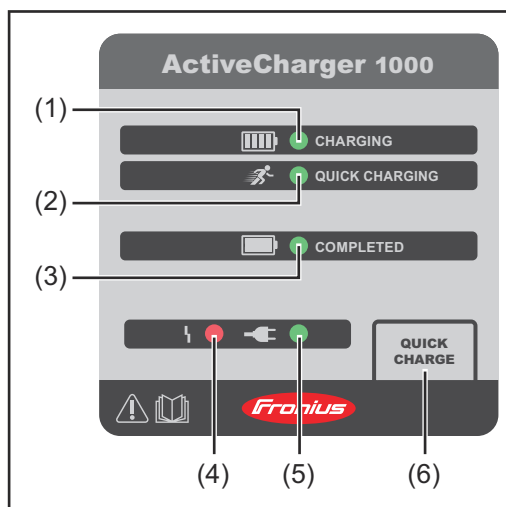

- (1) **CHARGING indicator (green)**  
Charging in progress
- (2) **QUICK CHARGING indicator (green)**  
Quick charging in progress
- (3) **COMPLETED indicator (green)**  
Power source fully charged
- (4) **Error indicator (red)**  
See section [Troubleshooting](#) on page [79](#)
- (5) **Mains indicator (green)**  
Mains supply voltage available
- (6) **QUICK CHARGE button**  
Starts and stops quick charging

# Start-up

## Safety

### **WARNING!**

#### **Danger from incorrect operation and work that is not carried out properly.**

This can result in serious personal injury and damage to property.

- ▶ All the work and functions described in this document must only be carried out by technically trained and qualified personnel.
- ▶ Read and understand this document in full.
- ▶ Read and understand all safety rules and user documentation for this device and all system components.

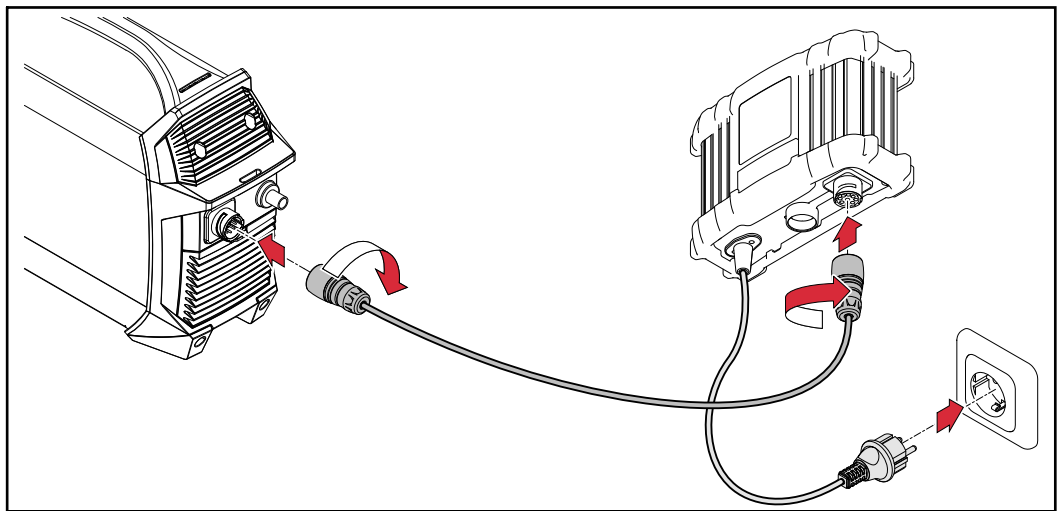

## Commissioning



-  Once connected, the battery capacity indicator on the power source flashes to indicate the current state of charge; the battery is being charged

- 2 Select Quick Charge mode if required - details on the available operating modes can be found in the following section

If the battery is fully charged:

-  The COMPLETED indicator lights up on the charger
-  On the power source, all segments of the battery capacity indicator are lit



### **NOTE!**

**The system includes the following features for maximum user-friendliness:**

- ▶ It does not matter in what order the devices are connected to the mains
- ▶ The power source can even be connected to the charger while it is in use

## Operating modes **Charging**



Starts automatically when the battery charger is connected to the power source and the mains

-  The CHARGING indicator is lit
-  Mains indicator lit
- The power source is charged at optimum charging power
- The charging characteristic of this mode maximises the service life of the power source
-  When the COMPLETED indicator lights up, the power source is fully charged and the battery charger switches to conservation charging mode

---

### Quick charging

Activation:

- 1 Press the QUICK CHARGING button
-  The QUICK CHARGING indicator is lit
  -  Mains indicator lit
  - The power source is charged at the maximum possible charging power
  -  When the COMPLETED indicator lights up, the power source is fully charged and the battery charger switches to conservation charging mode



Deactivation:

- 1 Press the QUICK CHARGING button again
  - Charging mode resumes

---

### Conservation charging

Starts automatically once the battery charger has fully charged the power source



-  Mains indicator lit
-  The COMPLETED indicator is lit
- The power source is charged at conservation charging power
- In this mode, the power source can remain connected to the charger without being damaged.

---

### Hybrid mode

= the battery charger is charging the power source while the power source is in operation

Activation:

- 1 Start welding during charging
  - 1 or connect the power source to the charger while it is in operation
-  The QUICK CHARGING indicator is lit (charging at the maximum possible charging power in hybrid mode)
  -  Mains indicator lit
  - The power source is discharged according to its operating load and simultaneously re-charged by the charger

# Options

## Fitting the wall bracket

### NOTE!

Depending on the underlying surface, different wall plugs and screws are needed to fit the wall bracket.

Wall plugs and screws are therefore not included in the scope of supply. The installer is responsible for selecting the correct wall plugs and screws.

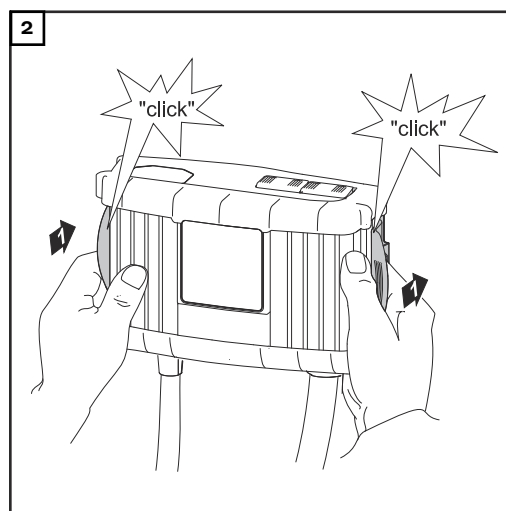
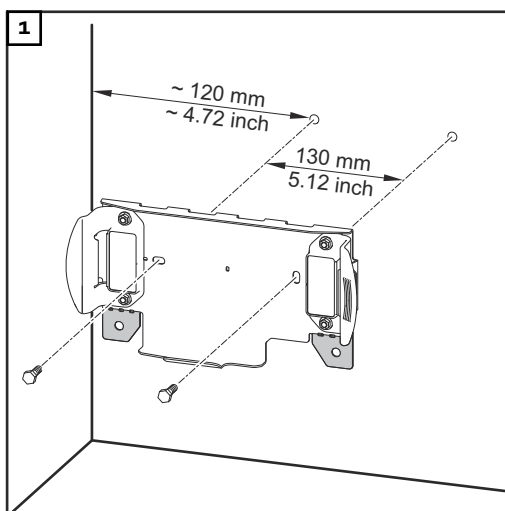

# Troubleshooting

## Safety

### **WARNING!**

#### **Danger from electric current.**

An electric shock can be fatal.

- ▶ Do not open the device.

## Indicated errors

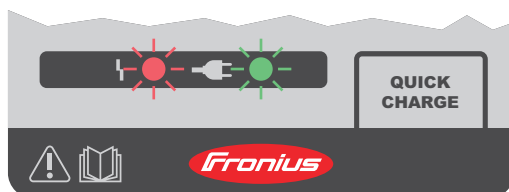

An error is signalled by the following indicators flashing or lighting up:

-  Error indicator
-  Mains indicator

#### **Error flashing, mains lit**

Cause: Battery fault

Remedy: Contact After-Sales Service

#### **Error flashing, mains flashing**

Cause: Mains fault (overvoltage or undervoltage)

Remedy: Check mains supply voltage (see Technical data)

#### **Error lit, mains lit**

Cause: Charger fault

Remedy: Contact After-Sales Service

## No function

#### **Mains fuse or automatic circuit breaker trips**

Cause: Mains fuse underrated/incorrect circuit breaker

Remedy: Fuse mains correctly (see Technical data)

Cause: Mains fuse trips in open circuit

Remedy: Contact After-Sales Service

# Technical data

---

## Environmental conditions

---

Transport, storage or operation of the device outside the stipulated range will be deemed improper. The manufacturer shall not be held liable for any damage arising from such usage.

---

Ambient air temperature range:

- During operation: -10 °C to + 40 °C (14 °F to 104 °F)
- During transport: -20 °C to +55 °C (-4 °F to 131 °F)
- Recommended temperature range during charging:  
+ 4 °C to + 40 °C (+ 39.2 °F to + 104 °F)
- Recommended temperature range during storage:  
0 °C to + 20 °C (+ 32 °F to + 68 °F)

When placing in storage, the state of charge should ideally be at 50 - 80% (corresponds to approx. 2 to 3 bars on the charging status indication).

---

Relative humidity:

- Up to 50% at 40 °C (104 °F)
  - Up to 90 % at 20 °C (68 °F)
- 

The surrounding air must be free from dust, acids, corrosive gases or substances, etc.

Can be used at altitudes up to 2000 m (6561 ft.)

---



**Technical data  
230V**

Mains voltage	~ 230 V AC, ±15%
Grid frequency	50/60 Hz
Mains current	max. 9.5 A eff.
Mains fuse protection	max. 16 A
Efficiency	max. 95 %
Effective power	max. 1100 W
Apparent power	max. 2370 VA
Power input (stand-by)	max. 2.1 W
Safety class	I (with ground conductor)
Maximum permitted mains impedance at the interface (PCC) to the public grid	None
EMC emission class	A
Mark of conformity	CE
Output voltage range	30 - 58 V DC
Output current	max. 18 A DC
Output power	max. 1040 W
Cooling	Convection and fan
Dimensions L x W x H	270 x 168 x 100 mm
Weight (without cable)	Approx. 2 kg
Protection class	IP43S
Overvoltage category Device may only be operated on neutral-earthed networks.	II

**Standards 230V**

EN 62477-1	
EN 60974-10	(Class A)

---

**Technical data  
120V**

Mains voltage	~ 120 V AC, ±15%
Grid frequency	50/60 Hz
Mains current	max. 15 A eff.
Mains fuse protection	max. 20 A
Efficiency	max. 94 %
Effective power	max. 1100 W
Apparent power	max. 1900 VA
Power input (stand-by)	max. 1.6 W
Safety class	I (with ground conductor)
Maximum permitted mains impedance at the interface (PCC) to the public grid	None
EMC emission class	A
<hr/>	
Output voltage range	30 - 58 V DC
Output current	max. 18 A DC
Output power	max. 1000 W
<hr/>	
Cooling	Convection and fan
Dimensions L x W x H	270 x 168 x 100 mm
Weight	Approx. 2 kg
<hr/>	
Protection class	IP43S
Overvoltage category	II
Device may only be operated on neutral-earthed networks.	

---

**Standards 120V**

UL 1012	
C22.2 No.107.1-01	
FCC CFR 47 Part 15	(Class A)

**Technical data  
100V**

Mains voltage	~ 100 - 110 V AC, +10% / -15%
Grid frequency	50/60 Hz
Mains current	max. 15.7 A eff.
Mains fuse protection	max. 16 A
Efficiency	max. 92 %
Effective power	max. 940 W
Apparent power	max. 1600 VA
Power input (stand-by)	max. 1.6 W
Safety class	I (with ground conductor)
Maximum permitted mains impedance at the interface (PCC) to the public grid	None
EMC emission class	A
Output voltage range	30 - 58 V DC
Output current	max. 15 A DC
Output power	max. 840 W
Cooling	Convection and fan
Dimensions L x W x H	270 x 168 x 100 mm
Weight	Approx. 2 kg
Protection class	IP43S
Overvoltage category Device may only be operated on neutral-earthed networks.	II

**Standards 100V**

EN 62477-1	
EN 60974-10	(Class A)









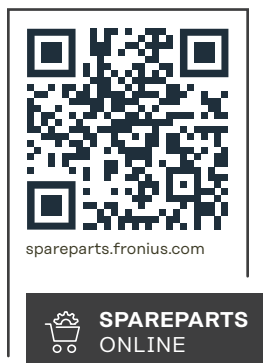

**Fronius International GmbH**

Froniusstraße 1  
4643 Pettenbach  
Austria  
[contact@fronius.com](mailto:contact@fronius.com)  
[www.fronius.com](http://www.fronius.com)

Under [www.fronius.com/contact](http://www.fronius.com/contact) you will find the addresses  
of all Fronius Sales & Service Partners and locations.